

The specifications and/or appearance of the products described in this catalogue are subject to change without previous notice because of necessary modification.



UNIQUE Smart Service & Solution

UNIQUE

Smart Service & Solution

CONTACT :

TAIZHOU UNIQUE MACHINE TECHNOLOGY CO., LTD.
TAIZHOU PIONEER IMP. & EXP. CO., LTD.

Address : A2-307, Xingxing E-commerce Industrial Park, NO. 1
Hongxi Road, Jiaojiang, Taizhou City, Zhejiang Province,
China

Mobile : 008618069305333 008615325597222
Email : sales@tzpioneer.com unique@tzpioneer.com
Website : www.unique-machine.cn www.tzpioneer.com

WHY US ?

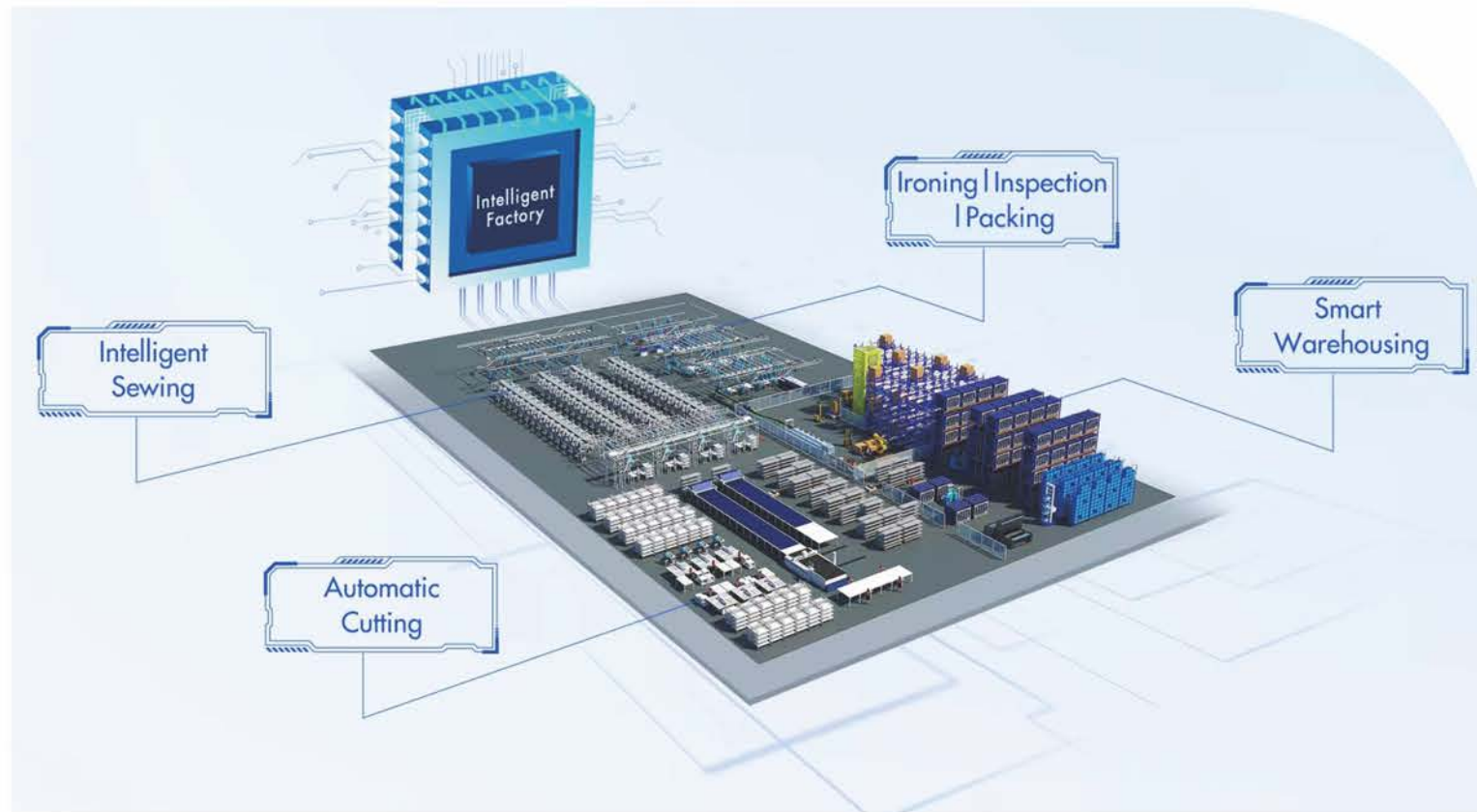

1000+
garment equipment & service provider.

200+
OEM customers

80+
countries our products have been sold to.

25+
years experience in machinery export

CERTIFICATES



CE



IEC



SGS



UNIQUE



PATENT

TOPDIS

01 **TEMPLATE SEWING MACHINE**

41 **SPECIAL SEWING MACHINE**

JEANS SEWING MACHINE
BUTTON HOLING
BUTTON ATTACHING & SNAP BUTTON
BAR TACKING
PATTERN SEWING
BLIND STITCH
SUIT & TROUSERS SEWING MACHINE
HAND STITCH
OTHER SPECIAL MACHINE

05 **OVERLOCK SEWING MACHINE**

13 **INTERLOCK SEWING MACHINE**

77 **SPECIAL FUNCTION MACHINE**

POSTBED LOCKSTITCH SEWING MACHINE
CYLINDER BED LOCKSTITCH SEWING MACHINE
SHOES & BAG MAKING MACHINE
BAG CLOSER MACHINE
ULTRASONIC & SEAMLESS MACHINE
MATTRESS & QUILTING MACHINE

21 **LOCKSTITCH SEWING MACHINE**

BASIC
DIFFERENTIAL FEED
WITH EDGE CUTTER
HEAVY DUTY
DOUBLE NEEDLE
LONG ARM

101 **EMBROIDERY & HOUSEHOLD SEWING MACHINE**

INDUSTRIAL EMBROIDERY MACHINE
HOUSEHOLD EMBROIDERY & SEWING MACHINE
KNITTING MACHINE

31 **ZIGZAG SEWING MACHINE**

HIGH SPEED
HEAVY DUTY

109 **FUSING MACHINE, STEAM BOILER, IRONING TABLE**

FUSING MACHINE
HEAT TRANSFER
DIGITAL SUBLIMATION PRINTER
IRON, BOILER & IRONING TABLE
IRON PRESSING MACHINE

35 **CHAINSTITCH SEWING MACHINE**

FLAT BED
FEED OF THE ARM

127 **CUTTING MACHINE & OTHERS**

CUTTING MACHINE
LASER CUTTING MACHINE
PACKING MACHINE
NEEDLE DETECTOR
COTTON & DOWN FILLING MACHINE
TROUSERS TURNERS &
DRAWSTRING INSERTING MACHINE
BUTTON WRAPPING MACHINE
THREAD DISTRIBUTOR
MOTOR & STAND TABLE
ACCESSORIES & PARTS

37 **MULTI-NEEDLE SEWING MACHINE**

MULTI-NEEDLE
SPECIAL FUNCTION



- PRODUCTION SOLUTION - FOR T-SHIRT & POLO SHIRT

- PRODUCTION SOLUTION - FOR SHIRT

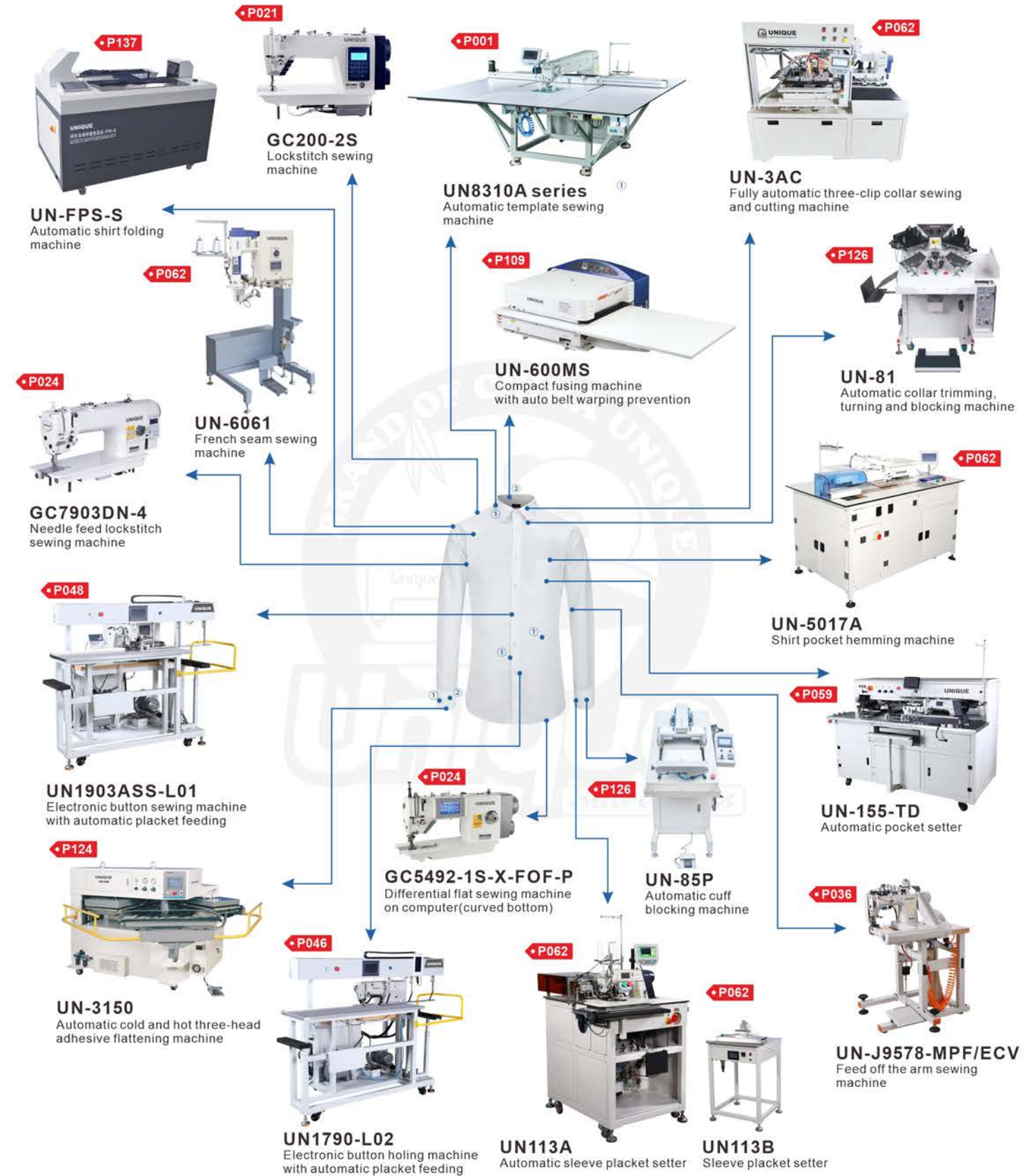
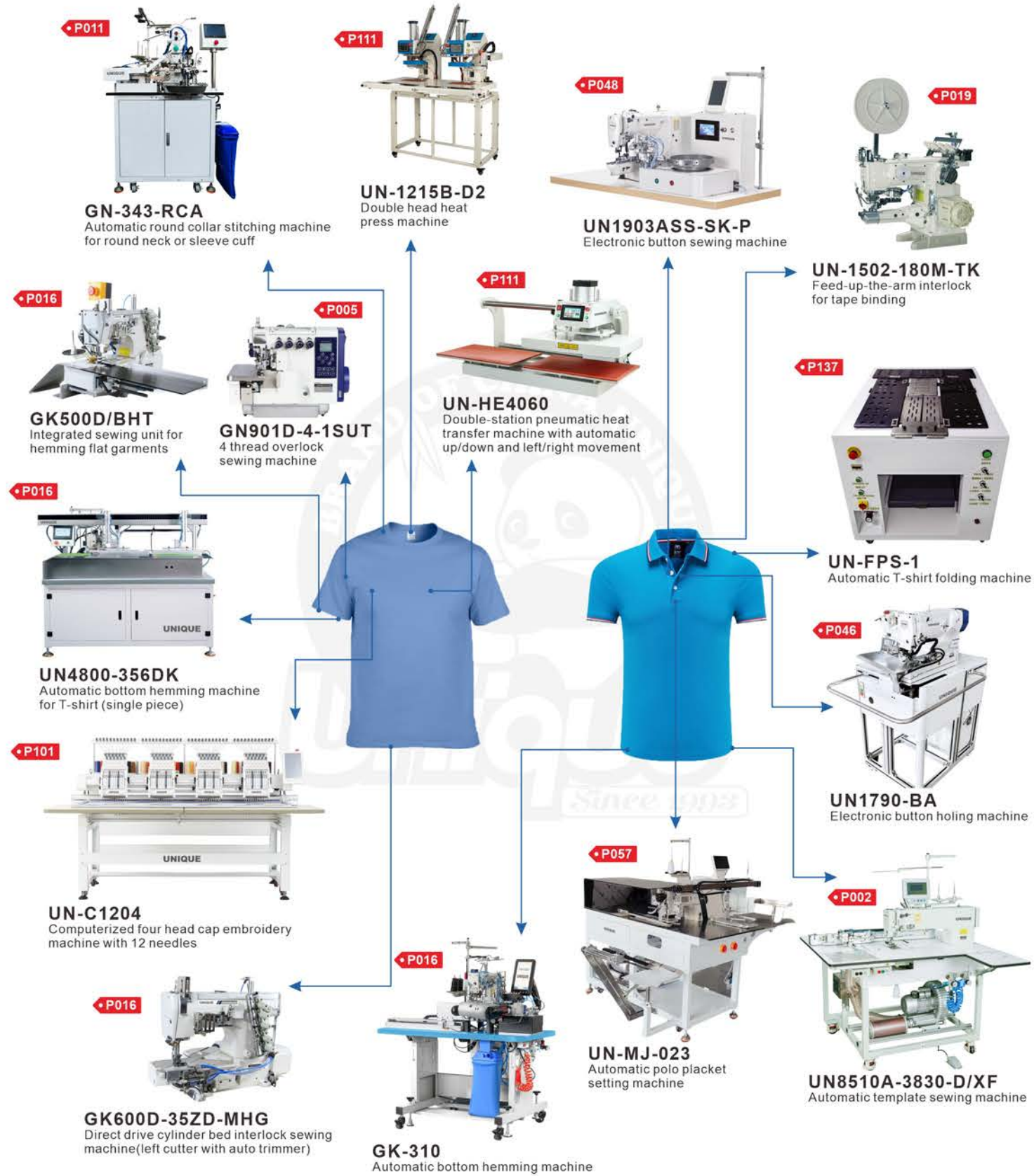

- PRODUCTION SOLUTION - FOR DOWN JACKET

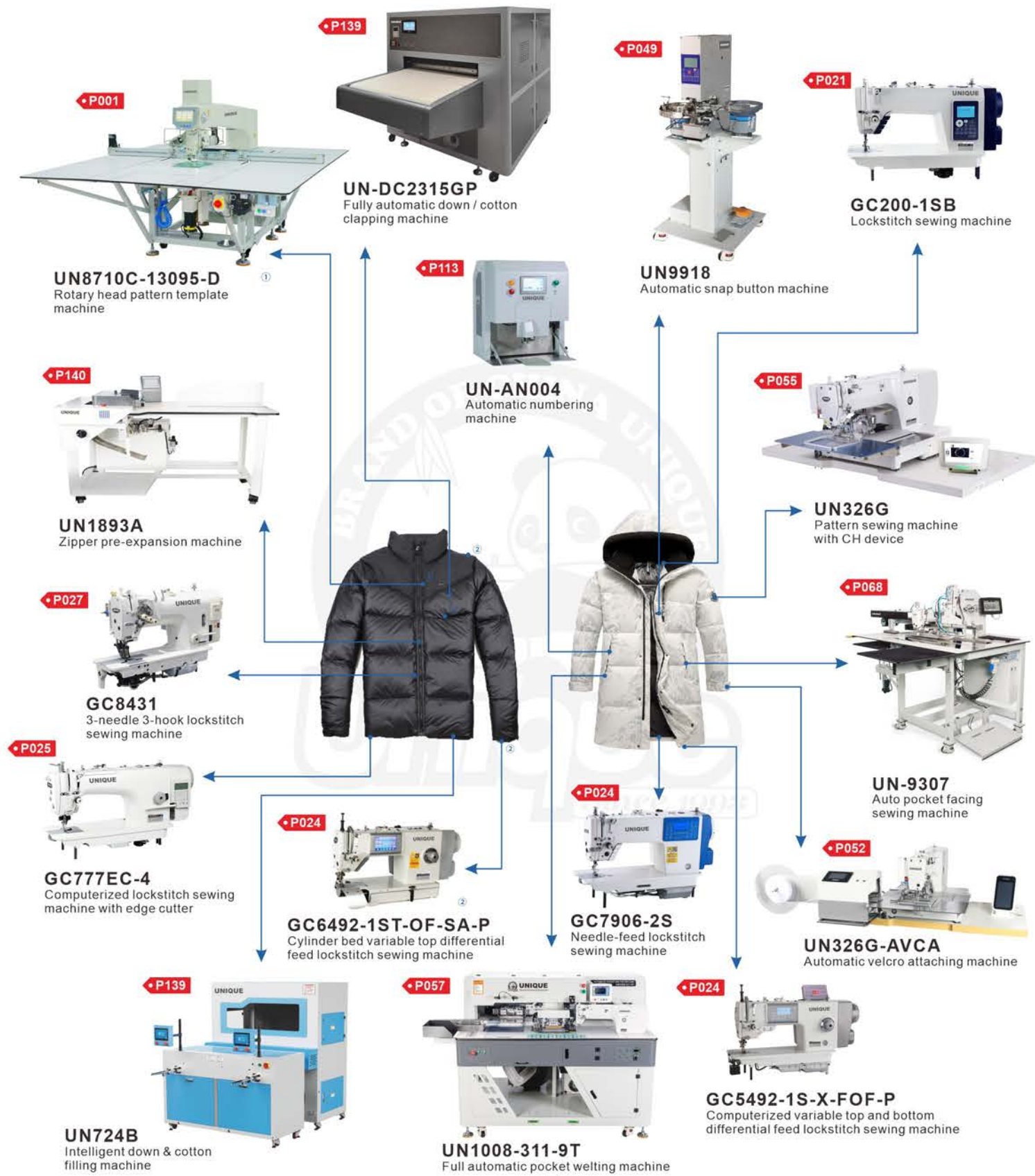

- PRODUCTION SOLUTION FOR SUIT

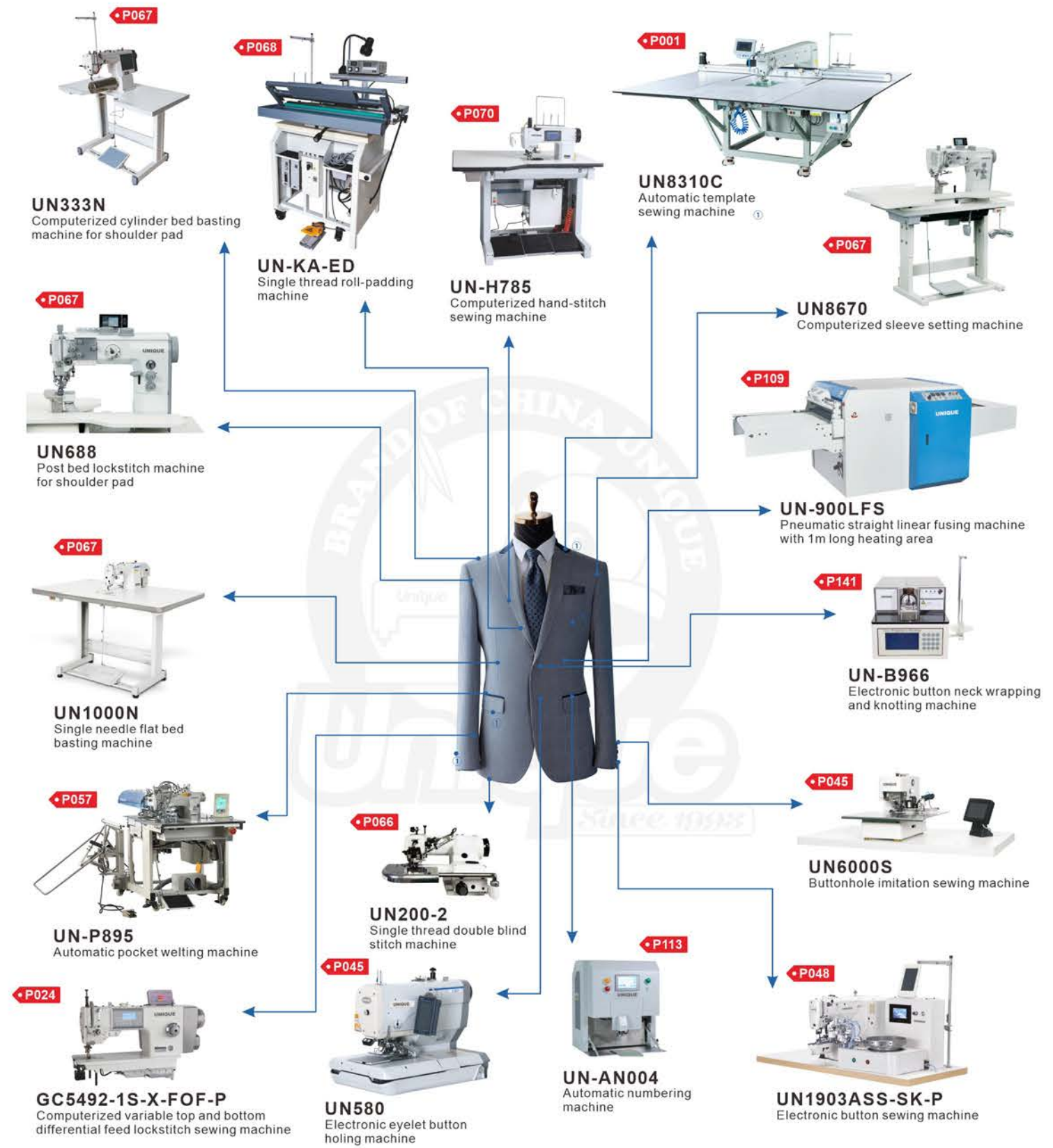

- PRODUCTION SOLUTION - FOR WINDBREAKER

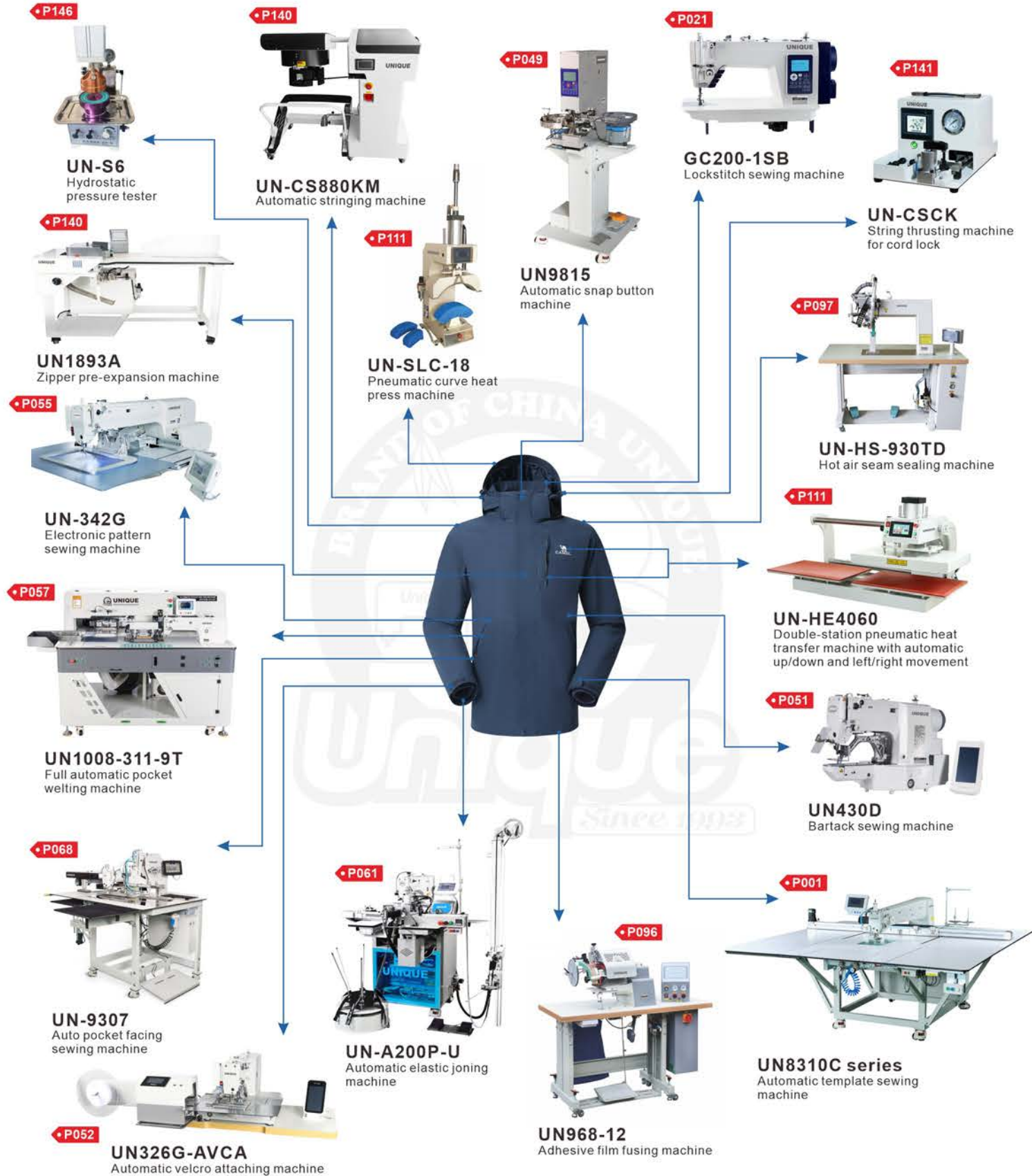

- PRODUCTION SOLUTION - FOR WOOLEN COAT

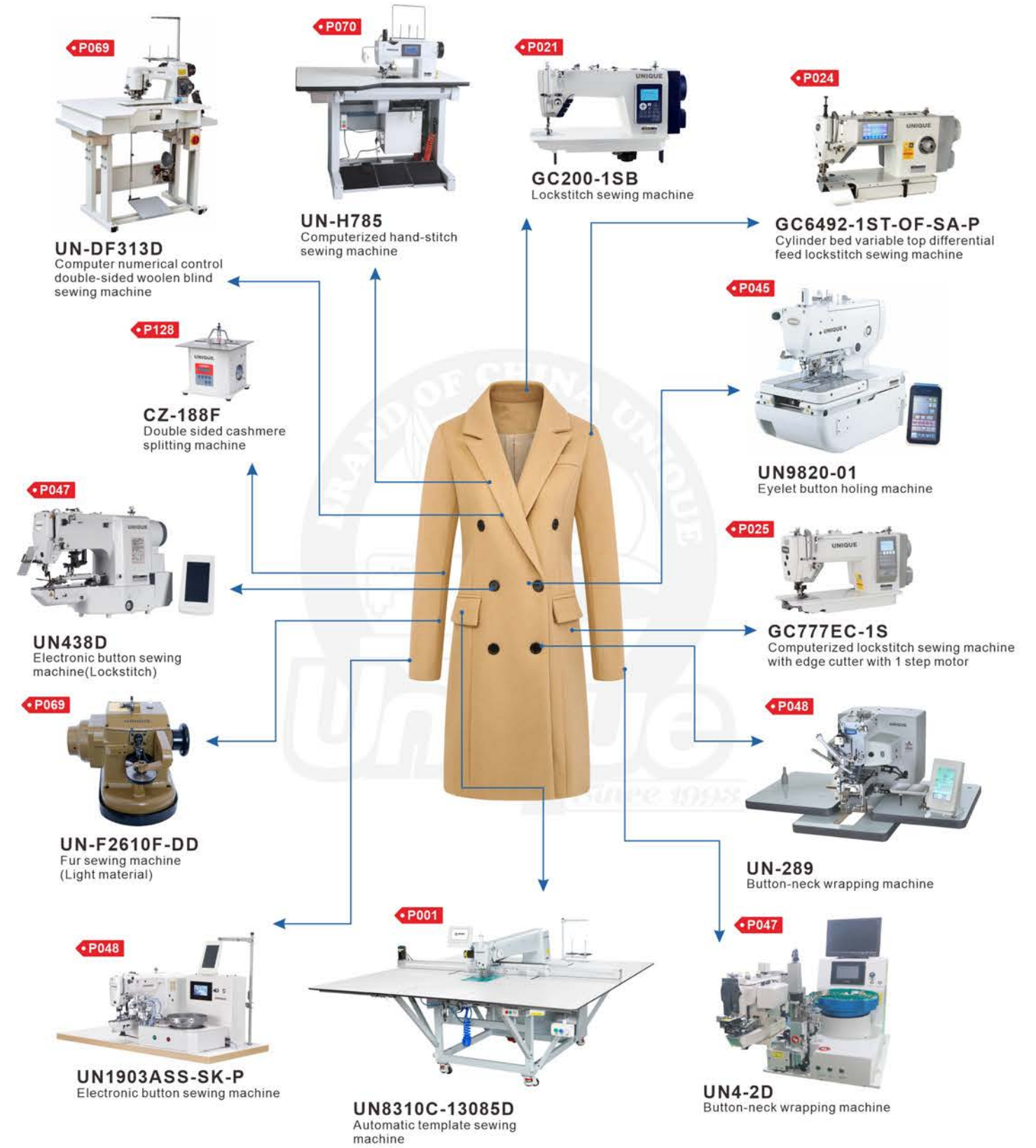

- PRODUCTION SOLUTION - FOR HOODIE & ATHLETIC PANTS

- PRODUCTION SO TOPDIS FOR CAMOUFLAGE UNIFORM

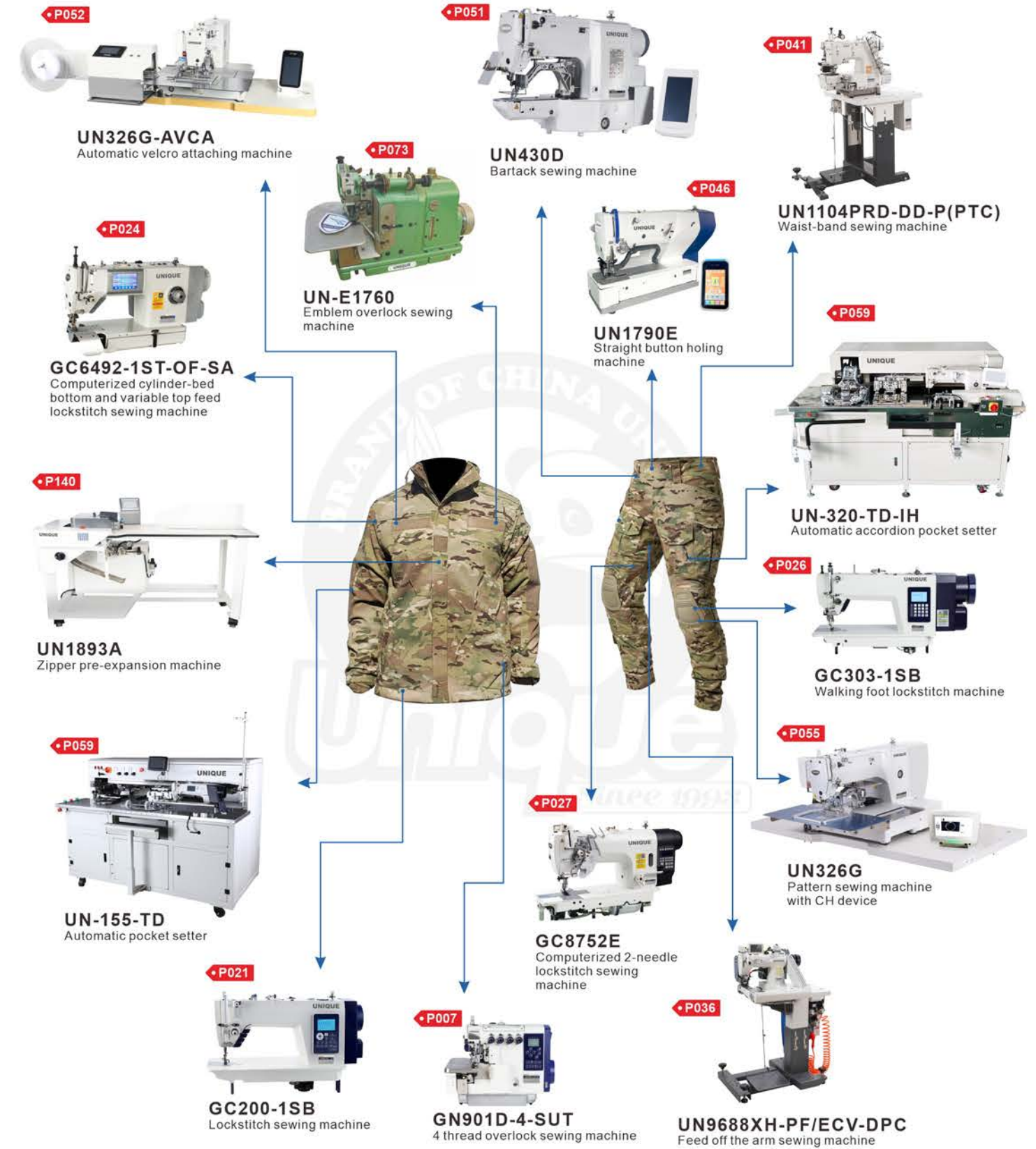

- PRODUCTION SOLUTION - FOR JEANS

- PRODUCTION SOLUTION FOR SUIT TROUSERS

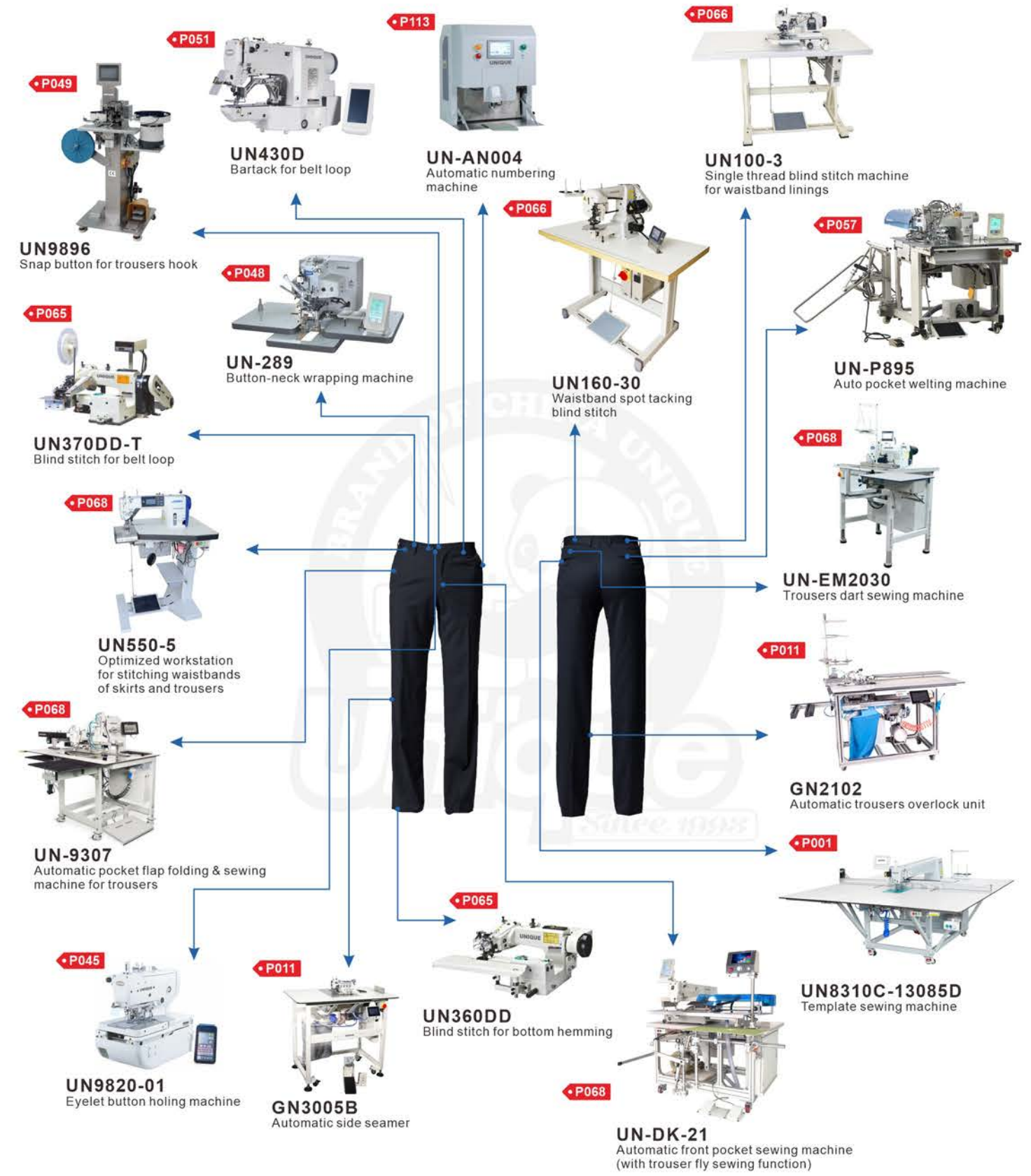
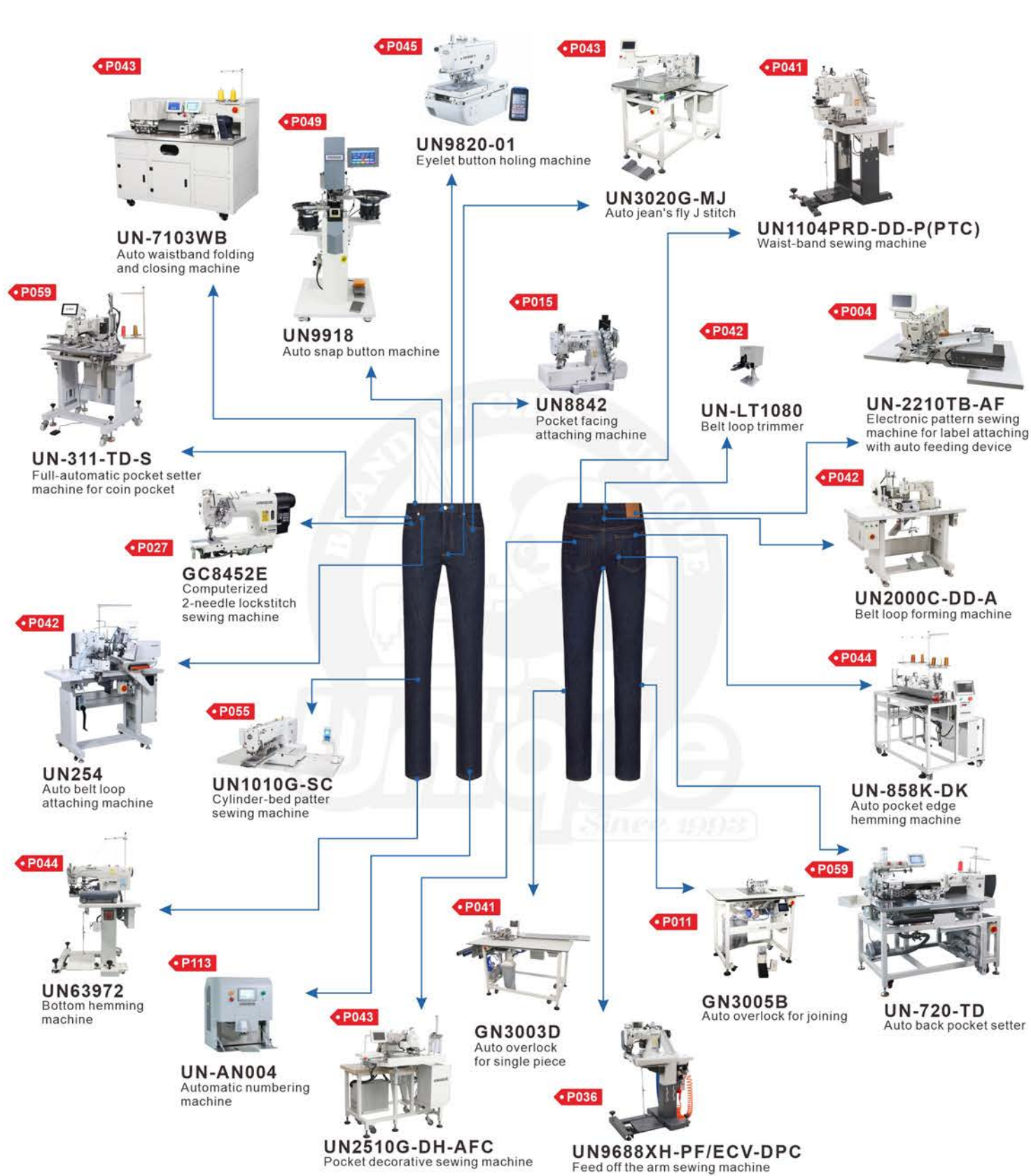

- PRODUCTION SOLUTION - FOR BRA & UNDERPANTS

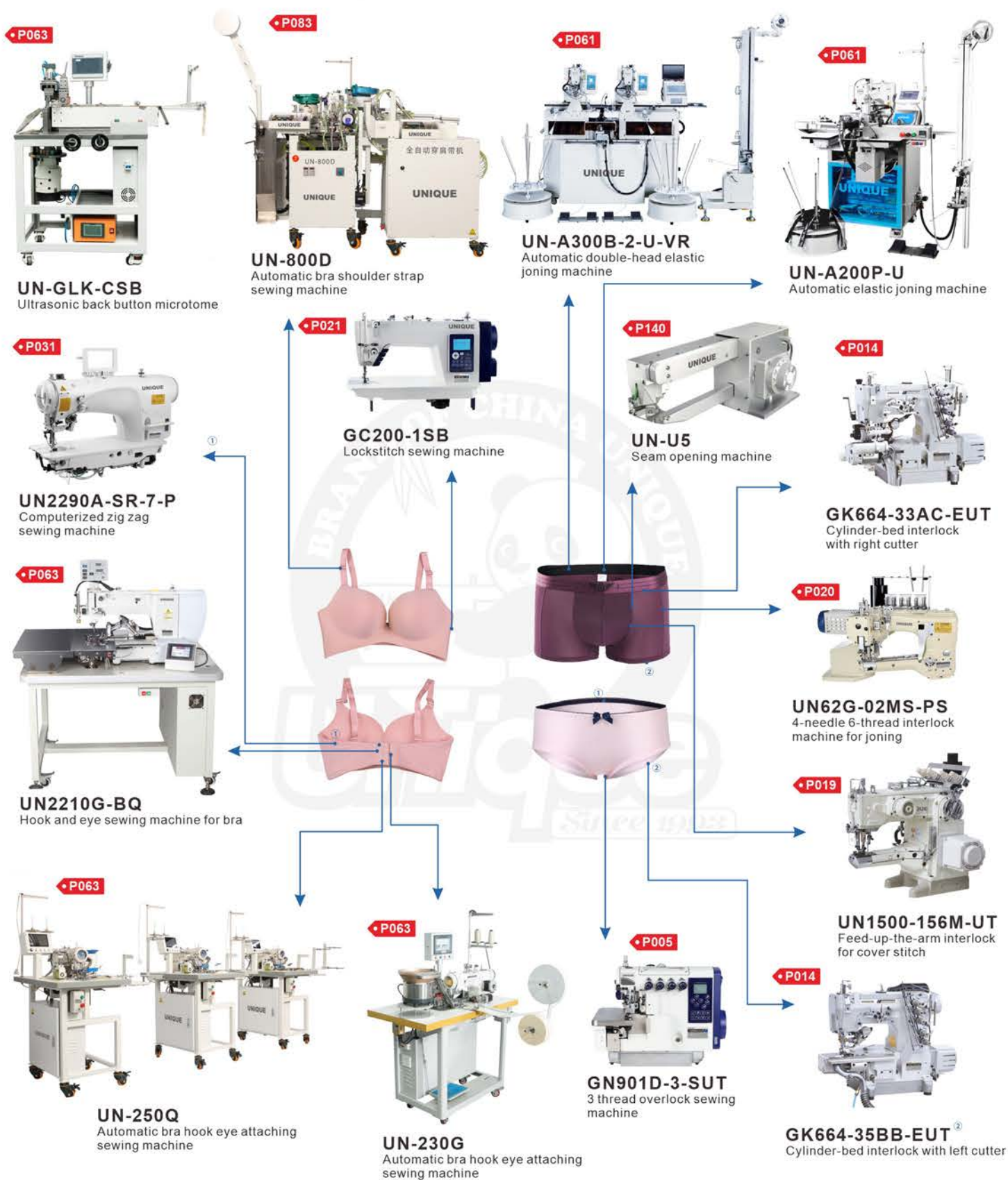

- PRODUCTION SOLUTION - FOR BACKPACK



- PRODUCTION SOLUTION - FOR CURTAIN

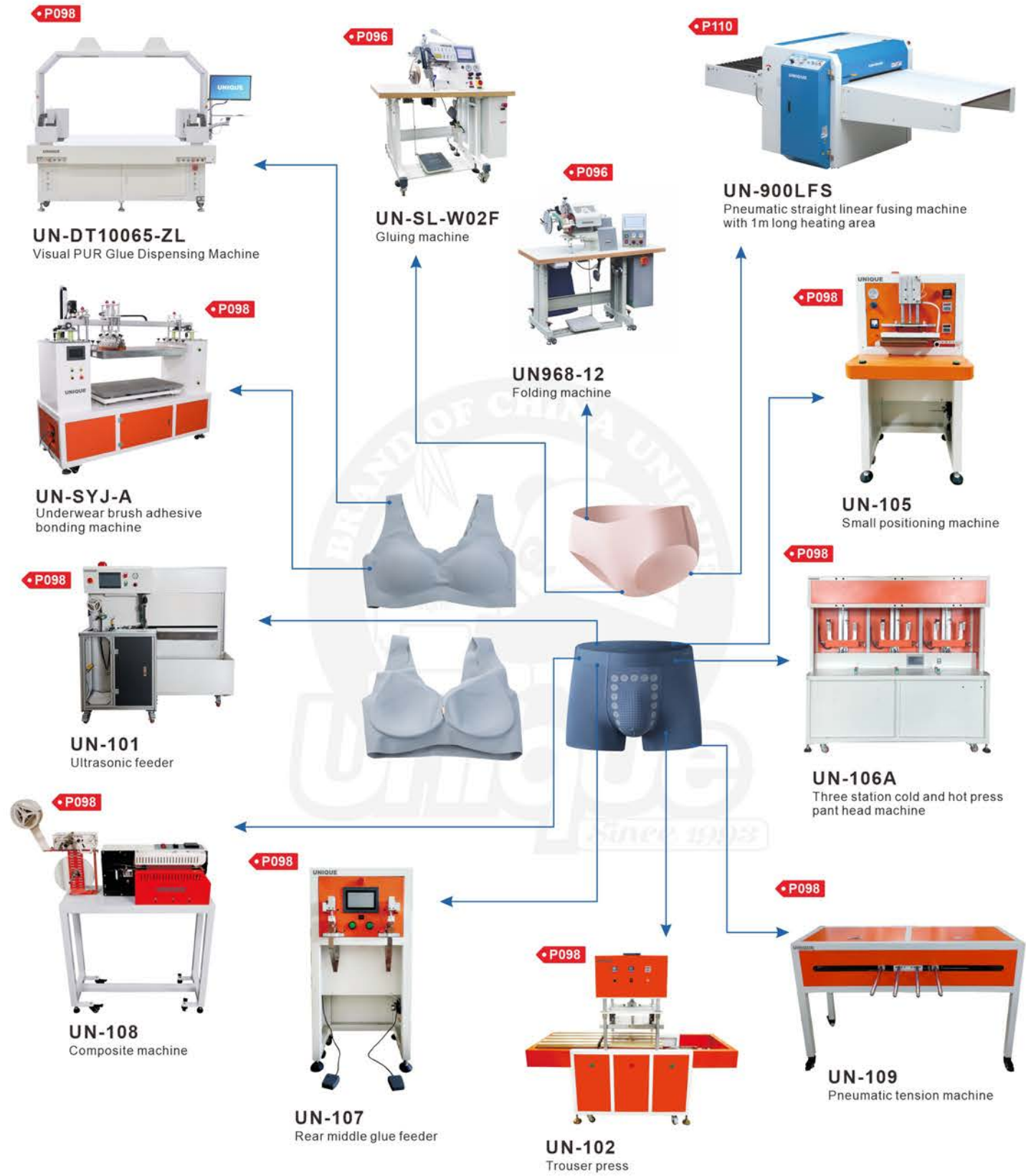

- PRODUCTION SOLUTION - FOR CAR INTERIOR



TEMPLATE SEWING MACHINE SERIES

High-speed oil-free pattern template machine



UN8310C-13085D (1300x850mm) basic type

- UN8310C-13085D/J With laser cutting
- UN8310C-13085-D/XF With suction function
- UN8310C-13085-D/QX With knife cutting
- UN8310C-13085H-D For heavy material



Rotary head pattern template machine

UN8710C-13095-D (1300x950mm) basic type

- UN8710C-13095-D/J With laser cutting



UN-X1D-13090 (1300x900mm) with ultrasonic cutting



TEMPLATE SEWING MACHINE

High-speed oil-free pattern template machine

TOPDIS



UN8110C-8045-D (800x450mm) basic type

- UN8110C-8045-D/XF With suction function
- UN8110C-8045-D/J With laser cutting
- UN8110C-8045-D/QX With knife cutting
- UN8110C-8045-D/J/XF With laser cutting, suction function
- UN8110C-8045-D/QX/XF With knife cutting, suction function
- UN8110C-8045-D/KD01 Laser + pocket wetting function



UN8510C-3830-D/XF (380x300mm) with suction function

- UN8510C-3830-D Basic type
- UN8510C-3830-D/QX/XF With knife cutting



Extra large sewing range pattern sewing machine

UN8310C-160105-D (1600x1050mm)

- UN8310C-200105-D (2000X1050mm)
- UN8310C-250105-D (2500X1050mm)



| Optional parts | H | A/C | B | J | QX | ZM | ZS | XF | |
|------------------|----------------|--|-----|-------|--|------------------------|-----------------------|----------------|---------------|
| Machine type | Heavy material | A: Xinghuo control box C: Dahao control box | Pen | Laser | Rotary cutter | Automatic mould change | Automatic hook change | Suction device | Suction range |
| UN8110C-8045-D | ★ | ★ | ● | ■ | ■ YD: Round knife JD: Scissor cutter | ○ | ● | ● | 400*400mm |
| UN8510C-3830-D | ★ | ★ | ● | ○ | ■ | ○ | ○ | ● | 280*280mm |
| UN8220C-12080-D | ★ | ★ | ● | ■ | ■ | ○ | ● | ● | 400*400mm |
| UN8310C-13085-D | ★ | ★ | ● | ■ | ■ | ○ | ● | ● | |
| UN8710C-13095-D | ★ | ★ | ● | ● | ○ | ● | ● | ● | 400*400mm |
| UN8310C-160105-D | ★ | ★ | ● | ■ | ■ | ○ | ● | ● | |

★ Optional ● Can be installed ○ Can not be installed ■ Gold knife and laser are optional, only one can be installed

High-speed oil-free pattern template machine



UN8100A-6041H-D
(600x410mm) for footwear and leather sewing

UN8400A-6055H-D
(600x550mm) Rotary head for leather sewing



UN8220A-12080-D
(1200x800mm) basic type

UN8220A-12080-D/J With laser cutting
UN8220A-12080-D/QX With knife cutting
UN8220A-12080H-D For heavy material

UN8800A-12085H-D
(1200x850mm)
Rotary head for footwear and leather sewing



UN8820A-12080H-D/SJ
(1200X800mm)
Oil-free rotary lifting head for airbag and leather sewing

UN8824A-23080H-D/ZM/ZS
(2300X800mm)
Oil-free rotary head for airbag and leather sewing
Automatic feeding function of left and right templates

Automatic template machine application

SHIRT PROCESS BREAKDOWN DIAGRAM

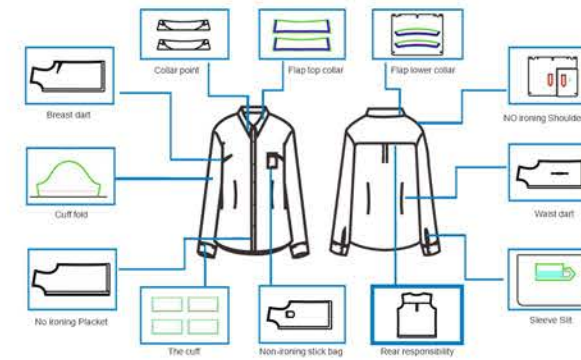

EXPLODED VIEW OF SUIT PROCESS

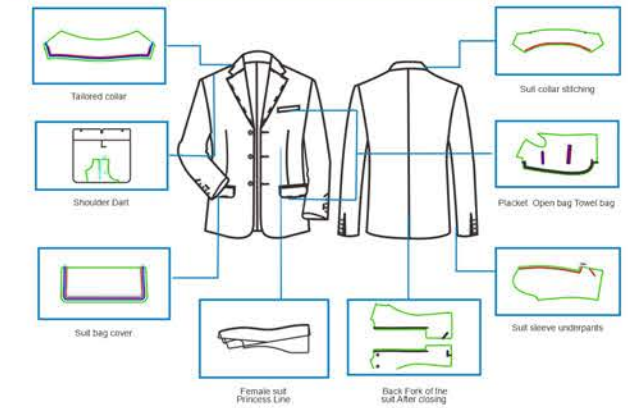

BREAKDOWN DIAGRAM OF TROUSERS PROCESS

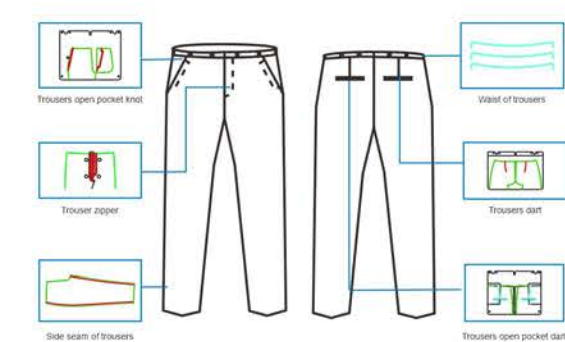

DECOMPOSITION DIAGRAM OF DOWN JACKET PROCESS

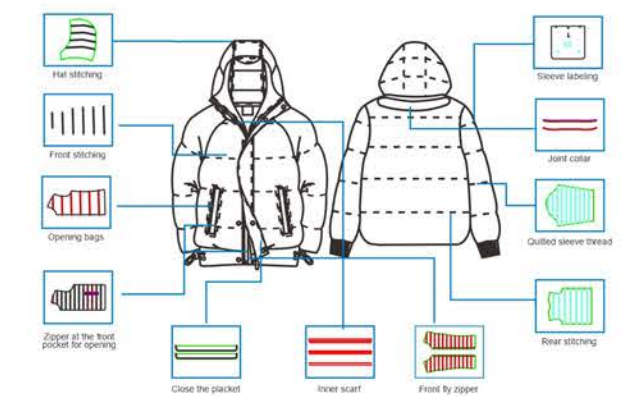

DECOMPOSITION DIAGRAM OF WINDBREAKER PROCESS

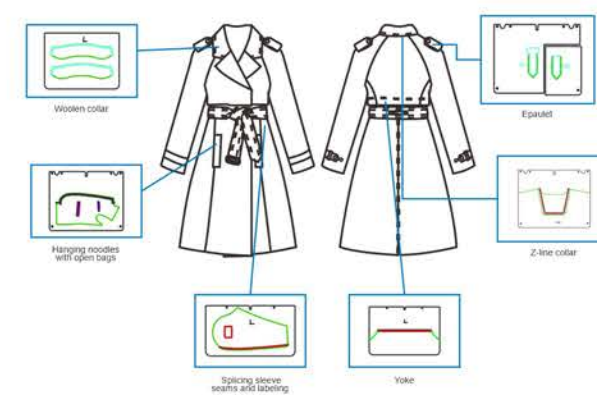

AUTOMOTIVE PROCESS DECOMPOSITION DIAGRAM

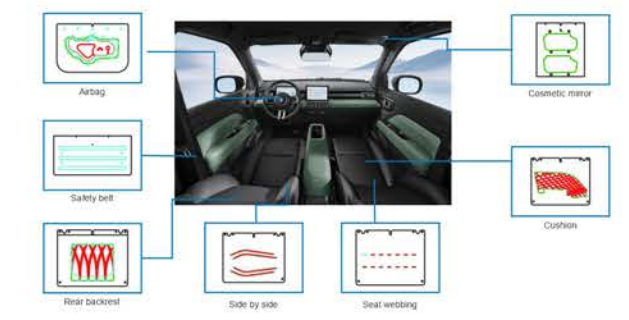

OVERLOCK SEWING MACHINE SERIES



GN901D-4-SUT
Auto trimmer by step motor

GN901D-3-SUT 3 thread
GN901D-4-SUT 4 thread
GN901D-5-SUT 5 thread



GN900D-4-EUT
Electronic auto trimmer

GN900D-3-EUT 3 thread
GN900D-4-EUT 4 thread
GN900D-5-EUT 5 thread



GNT900D-4-EUT
Top and bottom feed

GNT900D-3-EUT 3 thread
GNT900D-4-EUT 4 thread
GNT900D-5-EUT 5 thread



GN900D-4
Direct drive

GN900D-3 3 thread
GN900D-4 4 thread
GN900D-5 5 thread
GN900D-3/KS 3 thread with suction, 3.8mm
GN900D-4/KS 4 thread with suction, 7.0mm
GN900D-5/KH 5 thread with suction, 8.8mm

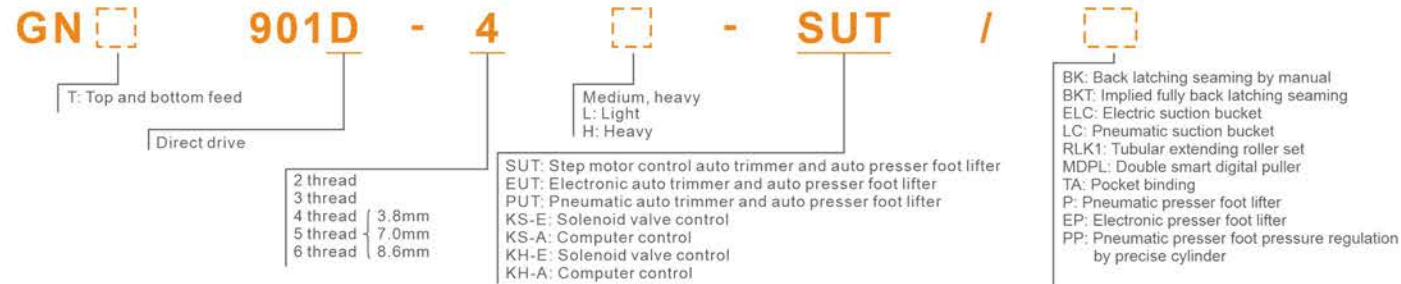

OVERLOCK SEWING MACHINE

TOPDIS



GN-MO7-4-SUT

GN-MO7-3-SUT 3 thread, auto trimmer, step motor
GN-MO7-4-SUT 4 thread, auto trimmer, step motor
GN-MO7-5-SUT 5 thread, auto trimmer, step motor



GN-MO7-4

GN-MO7-3 3 thread, direct drive
GN-MO7-4 4 thread, direct drive
GN-MO7-5 5 thread, direct drive



GN918D-4-SUT
Intelligent overlock sewing machine

Computerized overlock machine with step motor drive, auto thread trimming, and adjustable presser foot. It handles both thick and thin fabrics with consistent stitch quality.

GN918D-3-SUT 3 thread, auto trimmer, step motor
GN918D-4-SUT 4 thread, auto trimmer, step motor
GN918D-5-SUT 5 thread, auto trimmer, step motor



GN910D-4-SUT

GN910D-3-SUT 3 thread, auto trimmer, step motor
GN910D-4-SUT 4 thread, auto trimmer, step motor
GN910D-5-SUT 5 thread, auto trimmer, step motor
GN910D-3 3 thread, direct drive
GN910D-4 4 thread, direct drive
GN910D-5 5 thread, direct drive

GENERAL SEAMING

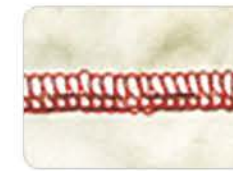

2 thread

GN727F-503M2-05



3 thread

For all overlock sewing machine



4 thread

For all overlock sewing machine



5 thread

For all overlock sewing machine

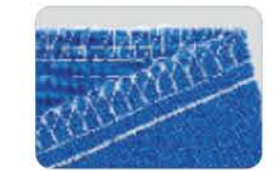

6 thread

GN767F-516M2-324
EX3244-03-333
GN-F5-6D
GN-F4-6D

SPECIAL STITCH



Narrow 3-thread overlock

GN737F-504M1-15
M752-16S2



For shower cap

GN737F-504M2-04TR



5 thread heavy duty

GN757F-516H2-56
EX3216H
EXT3216



5 thread wide stitch

GN757F-516M2-55
M732-70



Blind hemming

GN737F-505F1-04



EX5214DD-EUT

EX5204DD 3 Thread, direct drive
 EX5214DD 4 Thread, direct drive
 EX3216DD 5 Thread, direct drive
 EX5204DD-EUT 3 Thread, auto trimmer
 EX5214DD-EUT 4 Thread, auto trimmer
 EX3216DD-EUT 5 Thread, auto trimmer



Small Cylinder

EX5114DD

EX5104DD 3 Thread, direct drive
 EX5114DD 4 Thread, direct drive
 EX5104DD-KS-A 3 Thread, computer control
 EX5104DD-KS-E 3 Thread, solenoid valve control
 EX5114DD-KS-A 4 Thread, computer control
 EX5114DD-KS-E 4 Thread, solenoid valve control



Top and bottom feed

EXT5214DD-EUT

EXT5204DD 3 Thread, direct drive
 EXT5214DD 4 Thread, direct drive
 EXT3216DD 5 Thread, direct drive
 EXT5204DD-EUT 3 Thread, auto trimmer
 EXT5214DD-EUT 4 Thread, auto trimmer
 EXT3216DD-EUT 5 Thread, auto trimmer



Small Cylinder
Top and bottom feed

EXT5114DD

EXT5104DD 3 Thread, direct drive
 EXT5114DD 4 Thread, direct drive
 EXT5104DD-KS-A 3 Thread, computer control
 EXT5104DD-KS-E 3 Thread, solenoid valve control
 EXT5114DD-KS-A 4 Thread, computer control
 EXT5114DD-KS-E 4 Thread, solenoid valve control



GN-EC7-4-SUT

GN-EC7-3-SUT 3 thread, auto trimmer, step motor
 GN-EC7-4-SUT 4 thread, auto trimmer, step motor
 GN-EC7-5-SUT 5 thread, auto trimmer, step motor
 GN-EC7-3 3 thread, direct drive
 GN-EC7-4 4 thread, direct drive
 GN-EC7-5 5 thread, direct drive



GN940D-4-SUT

GN940D-3-SUT 3 thread, auto trimmer, step motor
 GN940D-4-SUT 4 thread, auto trimmer, step motor
 GN940D-5-SUT 5 thread, auto trimmer, step motor
 GN940D-3 3 thread, direct drive
 GN940D-4 4 thread, direct drive
 GN940D-5 5 thread, direct drive



With auto foot lifter

GN-F4-4D-P

GN-F4-3D-P 3 Thread, direct drive
 GN-F4-4D-P 4 Thread, direct drive
 GN-F4-5D-P 5 Thread, direct drive



GN-F3-4D

GN-F3-3D 3 Thread, direct drive
 GN-F3-4D 4 Thread, direct drive
 GN-F3-5D 5 Thread, direct drive



GN-F72-4D

GN-F72-3D 3 Thread, direct drive
 GN-F72-4D 4 Thread, direct drive
 GN-F72-5D 5 Thread, direct drive
 GN-F72-3D-EUT 3 Thread, auto trimmer
 GN-F72-4D-EUT 4 Thread, auto trimmer
 GN-F72-5D-EUT 5 Thread, auto trimmer
 GN-F72-3D-UT 3 Thread, auto trimmer only
 GN-F72-4D-UT 4 Thread, auto trimmer only
 GN-F72-5D-UT 5 Thread, auto trimmer only



GN-EC3-4D

GN-EC3-3D 3 Thread, direct drive
 GN-EC3-4D 4 Thread, direct drive
 GN-EC3-5D 5 Thread, direct drive



GN-F10-4D

GN-F10-3D 3 Thread, direct drive
 GN-F10-4D 4 Thread, direct drive
 GN-F10-5D 5 Thread, direct drive



GN747F-DD

GN737F-504M2-02 3 thread, basic model
 GN747F-514M2-24 4 thread, basic model
 GN757F-516M2-35 5 thread, basic model
 GN757F-516M2-55 5 thread, wide stitch
 GN767F-516M2-324 6 thread, basic model
 GN737F-DD 3 thread, direct drive
 GN747F-DD 4 thread, direct drive
 GN757F-DD 5 thread, direct drive



GN-F11-4D

GN-F11-3D 3 Thread, direct drive
 GN-F11-4D 4 Thread, direct drive
 GN-F11-5D 5 Thread, direct drive



M752DD-13

M752-17 3 thread
 M752-13 4 thread
 M752-13H 4 thread, heavy duty
 M732-38 5 thread
 M732-70 5 thread wide stitch
 M732-355 6 thread
 M752DD-17 3 thread, direct drive
 M752DD-13 4 thread, direct drive
 M732DD-38 5 thread, direct drive
 M752DD-17-EUT 3 thread, auto trimmer
 M752DD-13-EUT 4 thread, auto trimmer
 M732DD-38-EUT 5 thread, auto trimmer



GN6714D

GN6704S 3 thread
 GN6714S 4 thread
 GN6716S 5 thread
 GN6704D 3 thread, direct drive
 GN6714D 4 thread, direct drive
 GN6716D 5 thread, direct drive
 GN6704D-EUT 3 thread, auto trimmer
 GN6714D-EUT 4 thread, auto trimmer
 GN6716D-EUT 5 thread, auto trimmer



SMK: Elastic attaching
Electric metering type elastic tape feeding
EX5114DD-SMK
EXT5114DD-SMK
GN901D-4-SUT-SMK

LFC: Elastic attaching
Tape feeding device control the tension
GN737F-504M2-04-LFC
GN747F-514M2-04-LFC
EX5204DD-LFC
EX5214DD-LFC
For 3&4 thread overlock machine

RLK2: Tubular extending roller set
Extending by pneumatic
EX5114DD-RLK2
EXT5114DD-RLK2
EX5114DD-KS-RLK2
EXT5114DD-KS-RLK2



RLK3: Tubular extending roller set
Auto extending
EX5114DD-KS-RLK3
EXT5114DD-KS-RLK3

RLKA: Tubular extending roller set
Auto extending
EX5114DD-RLKA
EXT5114DD-RLKA

RLKA2: Tubular extending roller set
Auto extending
EX5114DD-RLKA2
EXT5114DD-RLKA2



GA: Gathering
GN757F-516H4-35-GA
GN757F-514H4-24-GA
M732-48GA
EX3216DD-GA

FG: Glove sewing
GN737FG-DD

BS: Blind stitch
EX5214D-BS

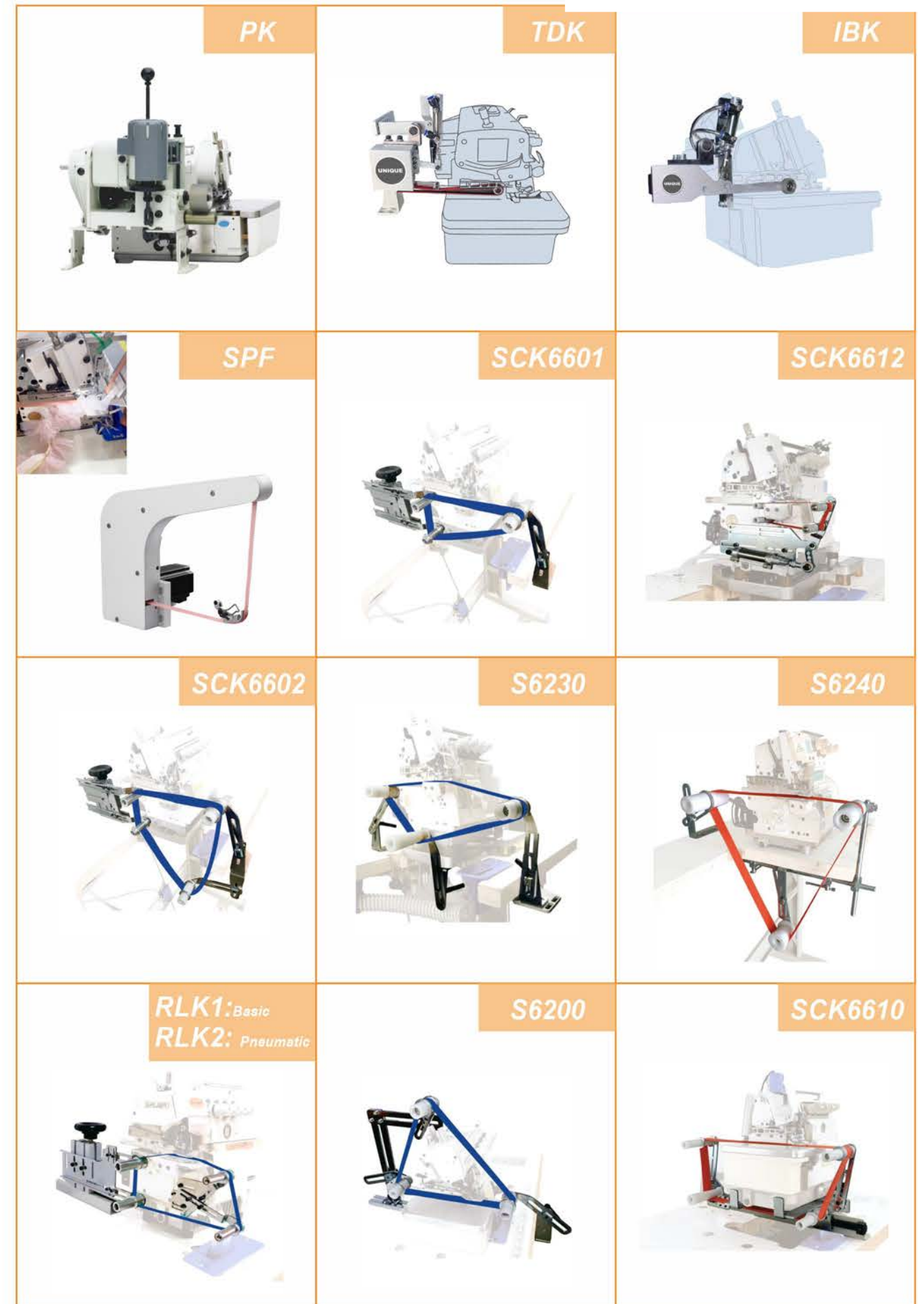

PK

TDK

IBK

SPF

SCK6601

SCK6612

SCK6602

S6230

S6240

RLK1: Basic
RLK2: Pneumatic

S6200

SCK6610



GN-343-RCA
Automatic round collar attaching machine for round neck or sleeve cuff



GN-360-RRBAM
Automatic rib cuff attaching machine



EXT5214-AC
Microcomputer cuff attaching machine



GN5104-GS
Microcomputer automatic glove overlock sewing machine



GN-343
Automatic elastic band or rib attaching machine



GN3005B
Automatic jeans side seamer for 2 pcs denim joining, 5 thread
GN3005B for suit trousers



EX5214D-GAP/BL
Automatic overlock sewing machine with auto backtacking, thread trimming & stacking



UN-R9-2UT
Microcomputer automatic cloth joining machine



GN2102
Automatic trousers overlock unit for single piece trousers overedging, 4 thread



GN3003D
Automatic denim overlock unit for single piece denim overedging, 4 thread



GN-21SM
Knitting hat head sewing machine



GN-21ST
Intelligent mop cloth overlock sewing machine

INTERLOCK SEWING MACHINE SERIES

INTERLOCK SEWING MACHINE

TOPDIS



GK562-01CB-EUT

FLAT-BED INTERLOCK SEWING MACHINE

- GK562E-01CB-SUT Integrated step motor control auto presser foot and auto trimmer
- GK562E-01CB-EUT Integrated electronic auto presser foot and auto trimmer
- GK562E-01CB-PUT Integrated pneumatic auto presser foot and auto trimmer
- GK562-01CB-EUT Electronic auto presser foot and auto trimmer
- GK562-01CB-PUT Pneumatic auto presser foot and auto trimmer
- GK562DD-01CB Direct drive
- GK562-01CB Basic model
- GK562DD-31 3 in 1(basic, roller-edge, cover stitch in one)
- GK562-01DB 4 needle 6 thread
- GK562-21BB Heavy duty

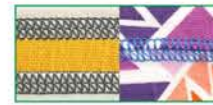

Stitch for GK562DD-31

GK562E-01CB-SUT



GK664-01CB-EUT

CYLINDER-BED INTERLOCK SEWING MACHINE

- GK664E-01CB-SUT Integrated step motor control auto presser foot and auto trimmer
- GK664E-01CB-EUT Integrated electronic auto presser foot and auto trimmer
- GK664E-01CB-PUT Integrated pneumatic auto presser foot and auto trimmer
- GK664-01CB-EUT Electronic auto presser foot and auto trimmer
- GK664-01CB-PUT Pneumatic auto presser foot and auto trimmer
- GK664DD-01CB Direct drive
- GK664-01CB Basic model
- GK664-01DB 4 needle 6 thread
- GK664-21BB Heavy duty

No. of needles: 2-3 needles
 No. of threads: 3-5 threads
 Needle space: 2-needles (3.2mm, 4.0mm, 4.8mm)
 3-needles (5.6mm, 6.4mm)
 Main feed dog's movement amount: 1.0-4.4mm
 Diff. feed dog's movement amount: 0.8-6.0mm*
 Presser foot lift: 5.3 mm*
 Maximum speed : 6,000 sti/min*

GK664E-01CB-SUT

>> Optional >>



- WP: Wiper device
For 2 needle 4 thread, 2 needle 3 thread
- ST: Surface thread trimmer device
3 needle 5 thread
- PWP: Pneumatic wiper device
2 needle 3 thread,
3 needle 4 thread
- SUT: Thread trimmer by Electronic
PUT: Thread trimmer by Pneumatic
SUT: Presser foot lifter and thread trimmer control by step motor
Under bed thread trimmer. This trimmer cuts needle and looper threads.
- MS: Condensed stitching device
- KH: Lower empty thread ring cutter device



- PL: Presser foot lift (Electronic or Pneumatic)
- N: Front mounted thread take-up cam
- PP: Pneumatic presser foot pressure regulation by precise cylinder.
- Cover stitch: GK562-03FB
GK562-03GB
GK664-03FB
GK664-03GB
- Stitchlock device



GK664S-01CB-PUT



GK562S-01CB



GK-H7-01CB-SUT
 GK-H7-01CB Direct drive
 GK-H7-01CB-EUT Auto trimmer



GK-H8-01CB-SUT
 GK-H8-01CB Direct drive
 GK-H8-01CB-EUT Auto trimmer



GK664-35BB-EUT
 GK664-35BB-PUT Pneumatic auto trimmer
 GK664DD-35BB Direct drive
 GK664-35BB Basic model



GK664-33AC-PUT
 GK664-33AC-EUT Auto trimmer
 GK664DD-33AC Direct drive
 GK664-33AC Basic model



GK562E-02BB
 GK562-02BB Basic type

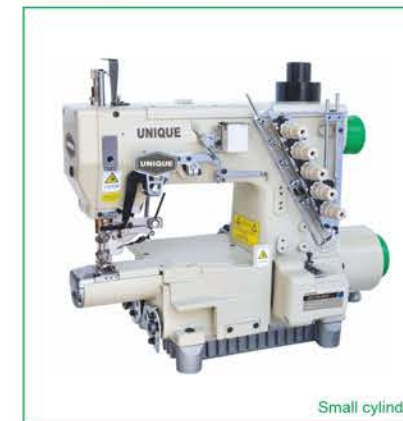

GK720-EUT
 GK720 Basic model
 GK720DD Direct drive
 GK720-EUT Auto trimmer



GK164-01CB-EUT
 GK164-01CB Basic model
 GK164DD-01CB Direct drive
 GK164-01CB-EUT Auto trimmer

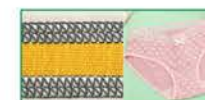

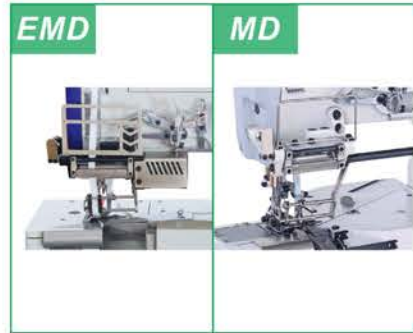

EMD: electronic metering device
GK562DD-05/EMD
GK664DD-05/EMD

MD: mechanical metering device
GK562DD-05/MD
GK664DD-05/MD



RTF: Tubular elastic waistband attaching
GK664-01CB/RTF



RP: Rear pullers
GK562-01CB/RP
GK664-01CB/RP

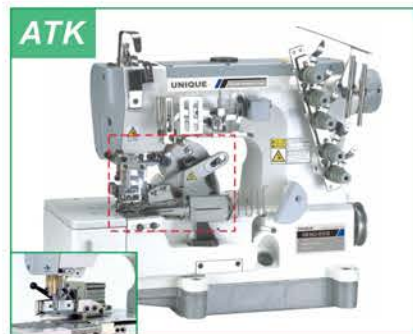

ATK: automatic taper cutter
MTK: manual taper cutter

GK562-02BB/TK
GK562-02BB/TK
GK562-04TK
GK562-07BB/ATK
GK562-02BB/ATK
GK562-04/ATK



3 needle 7 thread
UN8842-P With auto presser foot
UN8842
UN8842-UT Auto trimmer
UN8842-KH Auto trimmer
UN8842-ACD Auto collecting device



Blanket edging
GK562-23BB



Picotting stitch
GK562-10
GK562-10-VSM



GKT562-01CB-EUT
GKT562-01CB-PUT



GKT664-01CB-EUT
GKT664-01CB-PUT



GK562DL-70-01DB
Direct drive long arm flat-bed interlock sewing machine with 70cm working space



GKP562DL-70
Direct drive long arm post-bed interlock sewing machine with 70cm working space

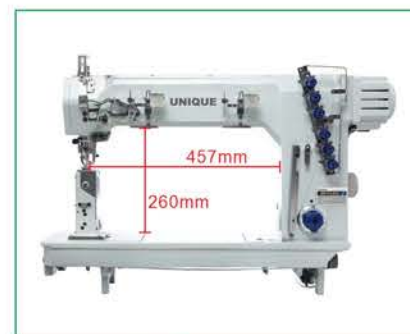

GKP-335-KFD
Direct drive walking foot 4-needle 6-thread interlock sewing machine with 457*260mm working space

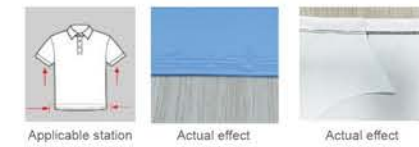
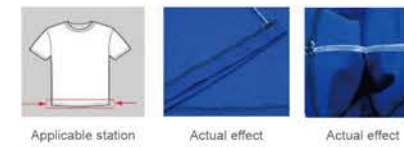

GK-310
Automatic coverstitch for T-shirt bottom hemmer



UN4800-356DK
Automatic bottom hemming machine for T-shirt (single piece)



GK500D/BHT
Integrated sewing unit for hemming flat garments



GK600D-35ZD-MHG
Direct drive cylinder bed interlock sewing machine (left cutter with auto trimmer)

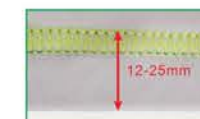

The size width is the same

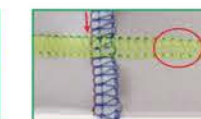

The stop was uniform and the bone position was even



GK-325
Automatic bottom rib attaching machine



GK-346-2
Automatic elastic waistband attaching machine



GK-346-3
Automatic coverstitch machine for tunnel elastic waistband



GK-375S
Automatic underwear elastic waistband attaching machine



GK787-EUT
GK787DD Direct drive
GK787-EUT Auto trimmer



GK787-FL-EUT
GK787DD-FL Direct drive
GK787-FL-EUT Auto trimmer



GK787-FR-EUT
GK787DD-FR Direct drive
GK787-FR-EUT Auto trimmer



GK720-FL-EUT
GK720DD-FL Direct drive
GK720-FL-EUT Auto trimmer



F007J-W122-356
F007J-W122-356 Basic model
F007JDD-W122-356 Direct drive
F007J-W222-356/FQ With binder
F007J-W122-356/EUT Auto trimmer



C007J-W122-356
C007J-W122-356 Basic model
C007JDD-W122-356 Direct drive
C007J-W222-356/FQ With binder
C007J-W122-356/EUT Auto trimmer



GK-3000ZP
Zipper sewing machine



GK2700VC-EUT
GK2700VC-EUT Auto trimmer
GK2700VC-DD Direct drive

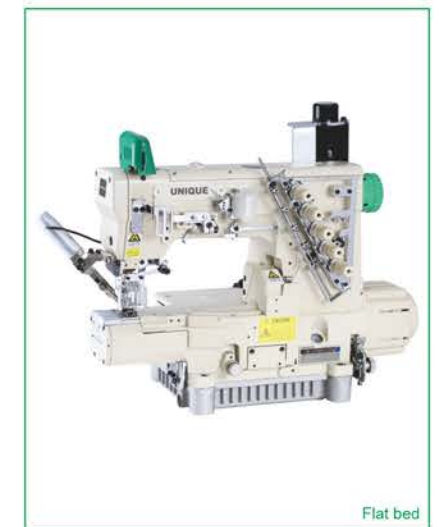

GK2700VG-EUT
GK2700VG-EUT Auto trimmer
GK2700VG-DD Direct drive

INTERLOCK SEWING MACHINE

Feed-up-the-arm Interlock sewing machine with auto trimmer

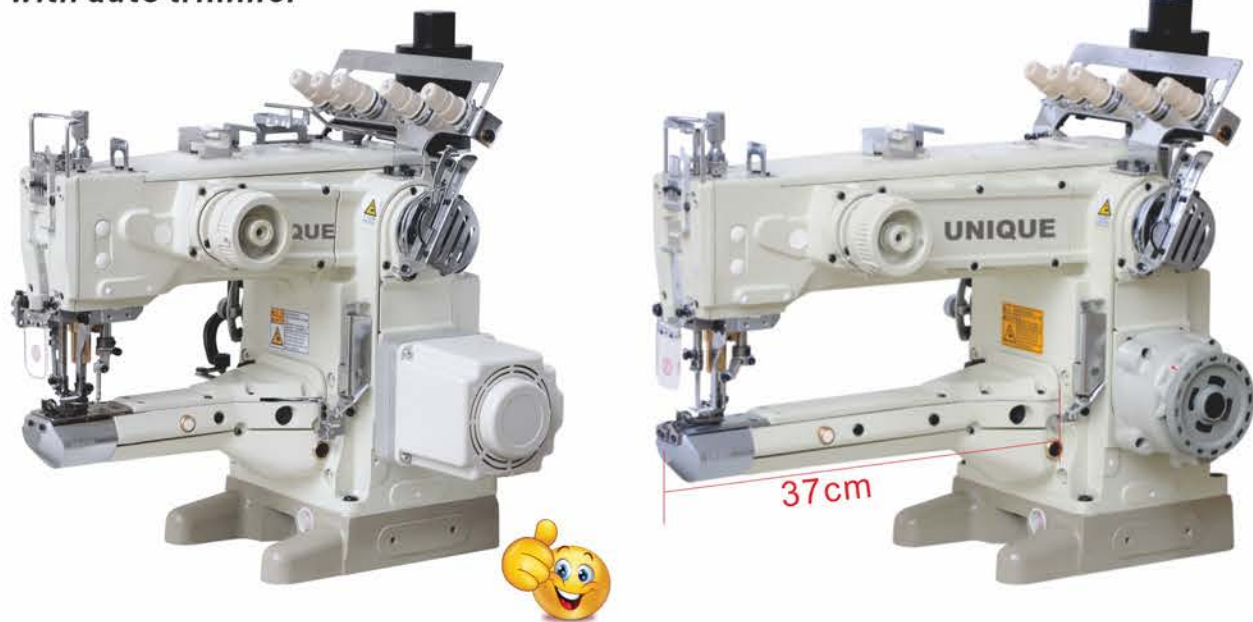

UN1500-156M-UT

UN1500-156M-L-UT

UN1500- 1 56 M - UT

MODEL

Straight cylinder interlock

PITCH

40:4.0mm
48:4.8mm
56:5.6mm
64:6.4mm

DECORATION

0: no upper decoration mechanism
1: upper decoration mechanism

NEEDLE PLATE

Needle plate shape

ATTACHMENT

DD: Direct drive
UT: Electronic auto trimmer
PUT: Pneumatic auto trimmer



UN1500-156M-PUT

UN1502-180M-TK

UN1560-160M-L-UT

| MODEL | NEEDLE | GAUGE | MODEL | NEEDLE | GAUGE | | |
|----------------|-------------------|-------|-----------------|------------------|-------------------------|---|-----------------|
| UN1500-156M | Basic model | 3 | 4 0/4 8/5 6/6 4 | UN1560-160M-DD | Direct drive | 4 | 5 6/6 0/6 4 |
| UN1560-160M | 4 needle 6 thread | 4 | 5 6/6 0/6 4 | UN1500-156M-UT | Auto trimmer | 3 | 4 0/4 8/5 6/6 4 |
| UN1502-180M | Tape attaching | 2 | 5 6/6 0/6 4 | UN1500-156M-PUT | Pneumatic auto trimmer | 3 | 4 0/4 8/5 6/6 4 |
| UN1500-156M-L | Long arm | 3 | 4 0/4 8/5 6/6 4 | UN1500-156M-L-UT | Long arm/Auto trimmer | 3 | 4 0/4 8/5 6/6 4 |
| UN1560-160M-L | Long arm | 4 | 5 6/6 0/6 4 | UN1502-180M-TK | Tape attaching | 2 | 5 6/6 0/6 4 |
| UN1500-156M-DD | Direct drive | 3 | 4 0/4 8/5 6/6 4 | UN1560-160M-L-UT | Electronic auto trimmer | 4 | 5 6/6 0/6 4 |

INTERLOCK SEWING MACHINE

4 needle 6 thread feed-off-the-arm interlock sewing machine (For joining)



UN62G-02MS-PS

UN740-02MS-SUT

UN62G-02 M S - PUT/PS

MODEL

62G: 4 needle 6 thread
740: 4 needle 6 thread

FABRIC THICKNESS

M: Light-Medium duty fabric
H: Heavy duty fabric

FABRIC CUTTER

01: single cut
02: double cut
03: single cut and tape attaching

GAUGE SIZE

R=5.2mm
S=6.0mm
T=8.0mm

ATTACHMENT

EUT: Electronic auto trimmer and foot lift
PUT: Pneumatic auto trimmer and foot lift
SUT: Step motor control auto trimmer and foot lift
PS: Pneumatic suction system
ES: Electronic suction system
DF: Double Differential feed



UN62G-01MR
UN62G-01MS
Underwear

UN62G-01MR
UN62G-01MS
Silk socks

UN62G-02HR
UN62G-02HS
Shoes

UN62G-HT
Bag

UN62G-02MR
UN62G-02MS
T-shirt
Thermal underwear

UN62G-02MR
UN62G-02MS
Swimming suit

| Icon | Model | Needle | Gauge | Foot | Trimmer | Suction | Speed |
|------|-------------------|---------|----------------|------|---------|---------|--------|
| | UN62G-02MS-PUT/PS | 1.6-2.5 | FLX118GCSx4-10 | 4 | 6 | ★ | 8 4200 |
| | UN62G-03MR-PUT/PS | 1.6-2.5 | FLX118GCSx4-10 | 4 | 6 | ★ | 8 4200 |
| | UN740-02MS-EUT/ES | 1.6-2.5 | FLX118GCSx4-10 | 4 | 6 | ★ | 8 4200 |
| | UN740-02MR-PUT/ES | 1.6-2.5 | FLX118GCSx4-10 | 4 | 6 | ★ | 8 4200 |
| | UN740-01MS-ES | 1.6-2.5 | FLX118GCSx4-10 | 4 | 6 | ★ | 8 4200 |
| | UN740-02MR-PS | 1.6-2.5 | FLX118GCSx4-10 | 4 | 6 | ★ | 8 4200 |

TOPDIS

LOCKSTITCH SEWING MACHINE SERIES

COMPUTERIZED LOCKSTITCH SEWING MACHINE WITH 2 STEP MOTORS



GC200T-2S
with touch screen panel



1 step motor for silent reverse stitching and 9 stitch patterns



1 step motor for silent automatic thread trimmer and foot lifter.



Sealed oil tank



9 stitch patterns programmable



High quality reverse stitches

GC200-2S



COMPUTERIZED HIGH SPEED LOCKSTITCH SEWING MACHINE WITH 1 STEP MOTOR



GC200-1SB



1 step motor for silent reverse stitching and 9 stitch patterns



The same step motor also controls the auto foot lifter.



9 stitch patterns programmable



High quality reverse stitches

>> Optional >>

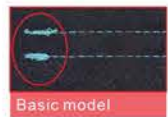

Basic model



Non-nest stitch



ABN



LG

Large hook



DK

Double round knife for thread trimmer

LOCKSTITCH SEWING MACHINE

TOPDIS



GC-ML5



Intelligent lockstitch sewing machine

Auto adaption from thin to thick material
1 step motor for silent reverse stitching and 9 stitch patterns and it also controls the auto foot lifter



GC-ML10



Intelligent lockstitch sewing machine
with 2 step motors - one for silent reverse stitching and 9 stitch patterns and the other one for silent automatic thread trimmer and foot lifter.
Standard model with 1 straight cutting blade for thread trimmer
GC-ML10-DK With double round knives for thread trimmer



GC-ML2

Direct drive lockstitch sewing machine with automatic thread trimmer
GC-ML1 Direct drive only



GC-ML11

Intelligent oil-free lockstitch sewing machine
Auto adaption from thin to thick material
305mm working area
with 2 step motors - one for silent reverse stitching and 9 stitch patterns and the other one for silent automatic thread trimmer and foot lifter.
Standard model with 1 straight cutting blade for thread trimmer



GC500-1S9

Intelligent lockstitch sewing machine
with auto adaption from thin to thick material
with 1 step motor, 30cm working area



GC200-D4

Computerized lockstitch sewing machine with automatic thread trimmer, foot lifter, reverse stitch
 GC200-D4-H Heavy duty
 GC200-D4-LG Heavy duty with large hook



GC200-D2

Direct drive lockstitch sewing machine with automatic thread trimmer **HOT DEAL**
 GC200-D2-H Heavy duty
 GC200-D2-LG Heavy duty with large hook



GC200-D1

Direct drive lockstitch sewing machine
 GC200-D1-H Heavy duty
 GC200-D1-LG Heavy duty with large hook



GC500-1S6

Intelligent lockstitch sewing machine with auto adaption to thin to thick material
 GC500-1S6 1 step motor
 GC500-1S7 2 step motor with 1 straight knife trimmer
 GC500-1S8 2 step motor with 2 round knife trimmer



GC600-D4

Computerized lockstitch sewing machine with automatic thread trimmer, foot lifter, reverse stitch
 GC600-D4-H Heavy duty
 GC600-D4-LG Heavy duty with large hook



GC600-D2

Direct drive lockstitch sewing machine with automatic thread trimmer
 GC600-D2-H Heavy duty
 GC600-D2-LG Heavy duty with large hook
 GC600-D1 Direct drive



GC750-1SC-PL

Computerized lockstitch sewing machine with 1 step motor for auto thread trimmer, foot lifter and back reverse stitch with 1 electronic puller
 GC750-1SC-2PL With 1 electronic puller and 1 lower puller



GC9100DD-1

Direct-drive lockstitch sewing machine



GC8700

GC8700 Basic model
 GC8700H Heavy duty
 GC8700LG Heavy duty, large hook
 GC8500 Basic model
 GC5550 Basic model



GC202-D4



GC202

GC6-9 Large hook, link lever driving
 GC6-9 Large hook, gear driving



GC6150

GC6150 Basic model
 GC6150H Heavy duty

DIFFERENTIAL FEED

Computerized bottom and variable top feed lockstitch sewing machine

GC 6 492 - 1ST - X - F OF - SA

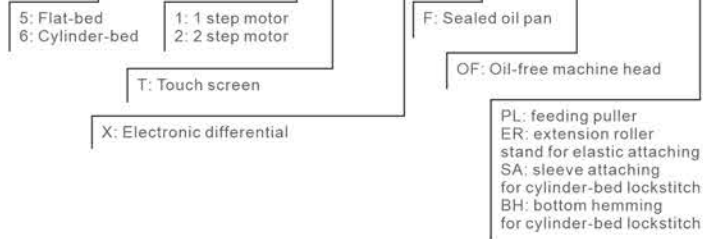

GC6492-1ST-OF-SA



Option



GC5492-1STP-X-FOF



GC5492-1ST-OF



GC5492-1S

NEEDLE FEED



GC7906-2S

Computerized needle feed lockstitch sewing machine with 2 step motors



GC7903DN-4

Computerized needle feed lockstitch sewing machine
 Long-arm version, different table sizes, optional large hook



GC7903DNT-4 With differential feed dog



GC7903DNE-4 With edge cutter
 GC7903DNB-4 With edge cutter and binder

EDGE CUTTER



Edge cutter



Edge cutter with binder



GC777EC-1S

Computerized lockstitch sewing machine with edge cutter with 1 step motor
Automatic thread trimmer, foot lifter, back-reverse stitch and 9 stitch patterns.



GC5490EC-4

Computerized differential feed lockstitch sewing machine with edge cutter with automatic thread trimmer, foot lifter, back-reverse stitch



GC777EC-4



GC777EC-DD



GC5200EC-4



GC5200ECB-DD



Compound feed

GC20606ECB



Walking foot

GC8422ECB



GC0303EC-4

GC0303EC-3 Foot lifter by knee
GC0303EC-4 Auto foot lifter



Complete working unit

GC1510-ECB-DD

GC1510-EC-DD Direct drive with auto foot lifter
GC1510-ECB Basic type
GC1510-EC Basic type



WALKING FOOT

Computerized Walking foot lockstitch sewing machine



GC303-1SB

Computerized walking foot single needle lockstitch sewing machine with 1 step motor
Automatic thread trimmer, foot lifter, back-reverse stitch and 9 stitch patterns.



- Auto thread trimmer
- Auto reversing stitch
- Auto stopping needle



-3 Foot lifter by knee
-4 Auto foot lifter



GC6910DDM-3



GC0303DDM-4



GC6437-D5

Computerized walking foot single needle lockstitch sewing machine with electronic presser foot height adjustable
Larger working space with length 370mm and height 140mm
GC6437-D4 regular type presser foot



GC640-H7-FL-D4

Computerized walking foot single needle lockstitch sewing machine
With head can lift up by 90mm and larger working space with length 370mm and height 140 to 230mm



GC640-D4

Computerized walking foot single needle lockstitch sewing machine
Larger working space with length 320mm



UN303-2S

2 step motor, sealed oil pan



GC303L-33-2S

Double thread clamp

Optional



GC0303D-1

GC0303D-CX With max stitch length 12mm
GC0303D-33 Direct drive with long arm 33cm
GC0303 Basic



UN-848

Automatic hat brim sewing machine



GC6303-SB

Small-bobbin tubular differential synchronizer (Large rotary hook)

DOUBLE NEEDLE

GC8452-S - 3 / P

- 4: Small hook
- 7: Large hook
- 5: Split needle bar
- 2: Fixed needle bar
- 3: Three needles
- 2: Micro oil, auto trimmer
- 1: Micro oil, direct drive
- DD: Direct drive, auto lubrication
- ND: Direct drive, new design, auto lubrication
- E: Integrated electronic control
- S: Stepper motor
- F: Split-type brother electronic control
- ECB: Integrated cutting & wrapping
- A: Auto cornering function
- ATC: Waist attachment, manual skip stitch, basic model
- BTC: Auto skip stitch, auto cutter
- 3: Thin material
- 5: Thick material
- P: Puller
- EP: Electronic puller

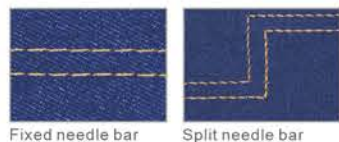

GC8422-S



GC8452E



GC8422-ATC
Direct drive 2-needle lockstitch sewing machine



GC8451
Direct drive 2-needle lockstitch sewing machine (micro oil)



GC845DD
2-needle lockstitch sewing machine



GC842ND
Direct drive 2-needle lockstitch sewing machine



GC8721TK
With rear tape and thread cutter



GC8752AP
Computerized 2-needle lockstitch sewing machine with auto switching from 2 needles to 1 needle for a perfect corner stitch



GC8431
3-needle 3-hook

COMPOUND FEED



GC20606DD-2N-4
Computerized 1 & 2 needle compound feed lockstitch sewing machine



GC20606E-2N
Direct drive 1 & 2 needle compound feed lockstitch sewing machine



GC20518M-DD
Direct drive 2-needle needle-feed lockstitch sewing machine



GC867-121232J
Computerized 1&2 needle lockstitch sewing machine with bottom feed, needle feed and alternating foot



GC0398-D4
Computerized compound feed lockstitch sewing machine



GC0368DD-4
Computerized 1 needle compound feed lockstitch sewing machine



GC1245
Compound feed lockstitch sewing machine



GC1580-DD-PL
Computerized 4 needle compound feed lockstitch sewing machine



GC1565
2 needle compound feed lockstitch sewing machine



GC1510 - DD-7
Computerized



GC1510-DD
Direct drive 1 needle compound feed lockstitch sewing machine



GC1560-DD-7
Computerized 2 needle compound feed lockstitch sewing machine

• **TEMPLATE**

GC9988L-56

GC9988L-36 36cm
GC9988L-56 56cm
GC9988L-85 85cm

- >>Optional>>
U type presser foot
Electronic puller
Roller presser foot
Large hook
Electronic control presser foot lifting
Steel plate
Laser sense
Start button in front
Needle bar, thread take-up bar without oil

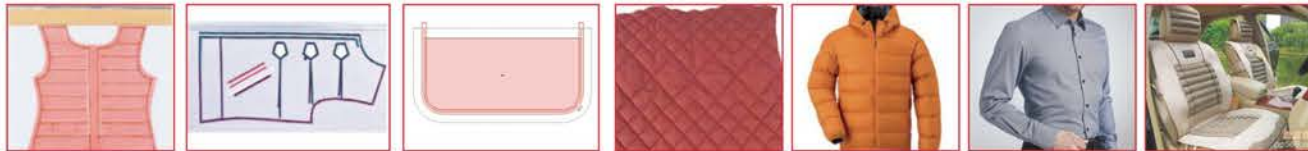
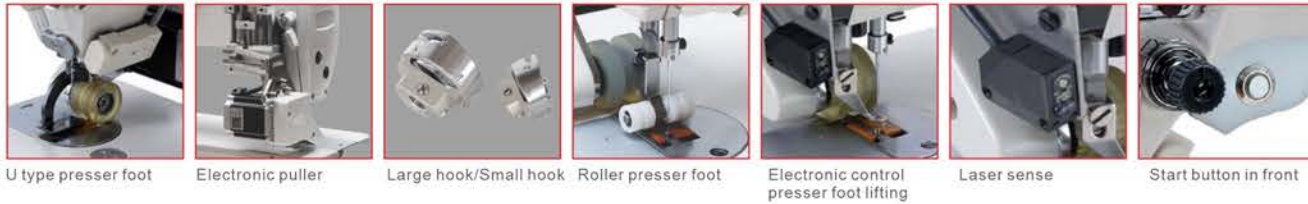

GC9990-7K

Automatic template machine with fabric cutter



GC8421-56

Direct drive 2-needle long arm lockstitch sewing machine



GC0303DL-56

GC0303DL-56 56cm



GC0617L-45-7-P

Computerized 45cm long arm compound feed lockstitch sewing machine

• **LONG ARM COMPOUND FEED**

GC20606L-2 - 4615 - 7-P

| | | |
|--------------------------|--|---|
| Long arm compound feed | 3310 330*100mm 4615 460*150mm 6515 650*150mm | 7-P Auto trimmer & pneumatic foot lifter D Direct drive / Basic with belt drive |
| 1 1-needle 2 2-needle | | |



GC20606L-2-7615-P
2-needle with 760*150mm space with pneumatic foot lifter
GC20606L-1-7615-P 1-needle



GC20606L-2-10210-P
2-needle with 1015*100mm space with pneumatic foot lifter
GC20606L-1-10210-P 1-needle

GC1560L - 6511 - 7-P

| | | |
|--|--|---|
| 1510L 1-needle 1560L 2-needle, fixed needle bar 1565L 2-needle, split needle bar | 3611 360*105mm 3613 360*125mm 4611 460*105mm 4615 460*150mm 6511 650*105mm 6515 650*150mm 7611 760*105mm 7615 760*150mm 10211 1015*105mm | *1565L series with height 105mm only 7-P Auto trimmer & pneumatic foot lifter D Direct drive / Basic with belt drive |
|--|--|---|



GC1560L-6511-7-P



GC1510L-3611-7-P



GC1560L-4615



GC1565L-4611-7-P

GC767L-2-7612-7-P

Computerized compound feed 2-needle lockstitch sewing machine with 760*120mm space with automatic thread trimmer and pneumatic foot lifter

| | |
|-------------------|------------------------|
| GC767L-1-7612 | 1-needle, basic |
| GC767L-1-7612-7-P | 1-needle, computerized |
| GC767L-2-7612 | 2-needle, basic |
| GC767L-2-7612-7-P | 2-needle, computerized |



| | | | | | | | | | | |
|---------------------|---|------|---|---|--------------|----|---|------|------|-----|
| GC20606L-2-4615-7-P | • | 1200 | • | 9 | DPX17 19-23# | 36 | • | 8/13 | 4-8# | M/H |
| GC1560L-6511-7-P | • | 1800 | • | 9 | DPX17 19-23# | 36 | • | 9/16 | 4-8# | M/H |
| GC767L-2-7612-7-P | • | 2000 | • | 9 | DPX17 19-23# | 37 | • | 9/16 | 4-8# | M/H |

ZIGZAG SEWING MACHINE SERIES

ZIGZAG SEWING MACHINE

TOPDIS



UN2290A - SR - 7 - P

Speed: 5000 rpm
 Max zigzag width: 8mm
 (Special request: 10mm)
 Max fabric feed amount: 2.5mm
 Height of presser foot:
 By hand: 5.5mm
 By knee: 10mm
 Pattern memory: 999 patterns

SS: Machine driven by step motor
 Back stitch control in Standard
 SR: Machine driven by step motor
 Back stitch control by step motor

7: Auto thread trimmer
 P: Auto presser foot lifting



UN2290A-SR-7-P



UN2284E-7-P



UN2284E-2-7-P



UN6284E-7
Cylinder-bed



UN2284DD-7-P



UN2284DD



UN2284

UN2284

E - 2 - 7 - P

UN2280: 1-step 2-point, Max zigzag width: 5mm
 UN2284: 1-step 2-point, 3-step 4-point, Max zigzag width: 8mm
 UN1622: Fagotting zigzag stitch

2: 2 needle
 7: Auto thread trimmer
 E: Computerized
 DD: Direct drive
 P: Auto presser foot lifting

Stitch for UN2280



Stitch and mould for UN2284

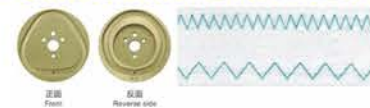

Stitch for UN1622



UN20U-1S



UN20U-2S

Multi patterns zig zag sewing machine

UN20U-1S 1 step motor with 190 patterns
 UN20U-1S-U 1 step motor with auto oil with 190 patterns
 UN20U-2S 2 step motor with 240 patterns
 UN20U-LR Lotus root stitch



190 patterns by 1 step motor



UN20U-LR



240 patterns by 2 step motors

UN20U53 - DD

UN20U23: 1-step, 2-point
 UN20U23D: Double needle
 UN20U33: 1-step, 2-point
 UN20U43: 1-step, 2-point
 UN20U53: 1-step, 2-point
 UN20U63: 1-step, 2-point
 UN20U93: 1-step, 2-point, oil lubrication

UN20U457A: 3-step, 4-point
 UN20U457B: 2-step, 3-point
 UN20U457D: 2 needle, 3-step, 4-point
 UN20U-830: For pearls-like linking
 UN20U-53B: For cap holes

DD: Direct drive

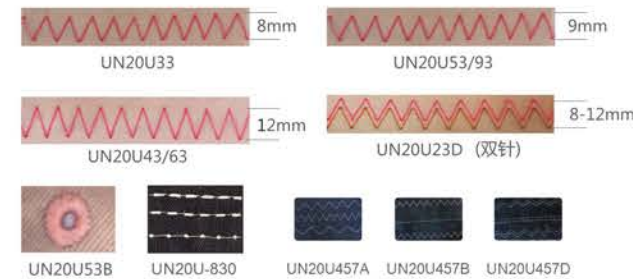
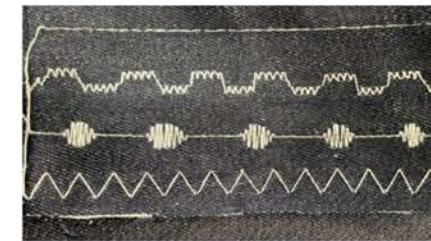

UN20U53-DD



UN20U43



UN652

Width and length of zigzag stitch is adjustable



ZIGZAG SEWING MACHINE

Optional touch screen
UN5530-1S-D4-PLUS



UN5530-1S-D4



UN5530-1S



UN5530-2S



190 patterns by 1 step motor 240 patterns by 2 step motors

Computerized zig zag sewing machine with multiple pattern designs

UN5530-1S 190 patterns by 1 step motor
UN5530-1S-D4 190 patterns by 1 step motor with auto thread trimmer foot lifter and reverse stitch
UN5530-2S 240 patterns by 2 step motors
UN5530-2S-D4 240 patterns by 2 step motors with auto thread trimmer foot lifter and reverse stitch



UN5530-S4

Computerized zigzag sewing machine with two step motor



UN5530-D4

Computerized zigzag sewing machine with automatic thread trimmer, foot lifter and reverse stitch



UN5530DD

Direct drive zigzag sewing machine

Large Hook, Oil Lubrication

UN1 53 0 DD

UN1: Standard feed
UN2: Up and down feed
0: 1-step 2-point
2: 2-step 3-point
3: 3-step 4-point
DD: Direct drive

53: Flat bed zigzag sewing machine
31: Cylinder bed zigzag sewing machine (small hook)
16: Feed off arm zigzag sewing machine
07: Feed off arm zigzag sewing machine (smaller cylinder)
45: Post-bed zigzag sewing machine



UN1530



UN1530DD



UN2530DD



UN2310DD



UN2160



UN2450

ZIGZAG SEWING MACHINE

TOPDIS



GC2530DL

Direct drive single needle long arm up and down feeding zigzag sewing machine



UN82801-D4-PL-L

Computerized long arm heavy duty zig zag sewing machine with puller

UN82801-D4-PL-L 14 patterns with auto trimmer & foot lifter with 740*115mm space
UN82801-D4-PL-LH 14 patterns with auto trimmer & foot lifter with 740*165mm space
UN82800-D4-PL-L Auto trimmer & foot lifter with 740*115mm space
UN82800-D4-PL-LH Auto trimmer & foot lifter with 740*165mm space



UN82801-D4



UN82800-D4



UN82800

| | | | | | | |
|----------|----------|----------|----------|----------|----------|----------|
| 70206059 | 70206060 | 70206061 | 70206062 | 70206063 | 70206064 | 70206065 |
| | | | | | | |
| 70206066 | 70206067 | 70206068 | 70206069 | 70206070 | 70206071 | 70206072 |
| | | | | | | |

UN82801 series with 14 zig zag patterns

Heavy duty zig zag sewing machine

UN82801-D4 Computerized with 14 patterns with auto trimmer, foot lifter and reverse stitch.
UN82801 Basic with 14 patterns
UN82800-D4 Computerized with auto trimmer, foot lifter and reverse stitch.
UN82800 Basic

Ultra heavy duty zigzag sewing machine with foot lifting and reverse stitch controlled by air, large hook, for big thread

UN366-76-12 760mm*173mm
UN366-76-12HA 760mm*273mm
UN366-76-12P 760mm*173mm with puller
UN366-76-12HAP 760mm*273mm with puller
UN368-32 320mm*185mm
UN368-76-12 760mm*173mm
UN368-76-12HA 760mm*273mm
UN368-76-12P 760mm*173mm with pneumatic puller
UN368-76-12HAP 760mm*273mm with pneumatic puller



UN366-76-12



Puller device for optional



UN368-76-12



UN5880-1S-2N

Step motor chainstitch sewing machine
 UN5880-1S-1N 1 needle
 UN5880-1S-2N 2 needles parallel
 UN5880-1S-2N(T) 2 needles tandem
 UN5880-1S-3N 3 needles in triangle
 UN5880-1S-3N(L) 3-needles in a line

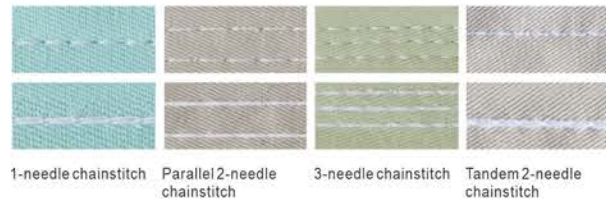

UN3800DD-2N

UN3800DD-1N 1 needle
 UN3800DD-2N 2 needles parallel
 UN3800DD-2N(T) 2 needles tandem
 UN3800DD-3N 3 needles in triangle
 UN3800DD-3N(L) 3-needles in a line
 UN3800DD-4N(L) 4-needles in a line



UN5800E-2N

Direct drive chainstitch sewing machine
 UN5800E-1S-2N(T) 2 needles tandem
 UN5800E-1S-3N 3 needles in triangle
 UN5800E-1S-3N(L) 3 needles in a line



UN3800DD-2N-VPL

Direct drive chainstitch sewing machine



UN3800DD-3N-PL

Direct drive chainstitch sewing machine
 UN3800DD-3N 3 needles in triangle
 UN3800DD-3N(L) 3-needles in a line



UN5480C-2N

Direct drive differential feed chainstitch sewing machine with auto foot lifter by step motor
 UN5480C-1N 1 needle
 UN5480C-2N 2 needles
 UN5480C-3N 3 needles



UN5480C-2N-ECB-PL

Direct drive differential feed chainstitch sewing machine with auto foot lifter with edge cutter with puller
 UN5480C-1N-ECB-PL 1 needle
 UN5480C-2N-ECB-PL 2 needles
 UN5480C-3N-ECB-PL 3 needles



UN0056T-2N

Direct drive walking foot chainstitch sewing machine
 UN0056T-1N 1 needle
 UN0056T-2N 2 needles
 UN0056T-3N 3 needles
 *Auto foot lifter is available for option



UN3800DD-3N-UT

Direct drive chainstitch sewing machine with auto trimmer
 UN3800DD-1N-UT 1 needle
 UN3800DD-2N-UT 2 needles parallel
 UN3800DD-2N(T)-UT 2 needles tandem
 UN3800DD-3N-UT 3 needles



UN0056-2N(P)-R

Direct drive chainstitch sewing machine with auto reversing stitch
 UN0056-1N-R 1 needle
 UN0056-2N-R 2 needles parallel
 UN0056-2N(T)-R 2 needles tandem
 UN0056-3N-R 3 needles



UN3800DL-2N-83

Long arm chainstitch sewing machine
 UN3800DL-1N-46 1 needle 46cm
 UN3800DL-2N-46 2 needles 46cm
 UN3800DL-3N-46 3 needles 46cm
 UN3800DL-1N-83 1 needle 83cm
 UN3800DL-2N-83 2 needles 83cm
 UN3800DL-3N-83 3 needles 83cm



Edge cutter UN3800DD-2N-VPL UN3800DD-2N(T) UN3800DD-3N UN3800DD-3N(L) Metal gear puller Rubber gear puller Rubber flat puller



UN9688XH-PF/ECV-DPC

High speed full-function feed off the arm chainstitch sewing machine

Speed reaches up to 5500rpm, 3-needle, heavy duty, excellent for jeans
 UN9688XH-PF/ECV-DPC
 UN9688XH-PF/ECV

PF



External gearbox, crawler type feeding puller

ECV



Electric thread trimmer and suction device, pneumatic valve to control puller, presser foot and needle cooling device

DPC



Sensor for lifting foot to climb over heavy material



UN261-3
 High-speed heavy-duty feed-off-the-arm 3-needle chainstitch sewing machine
 UN261-2 2-needle



UN9588-PF/ECV
 Automatic feed off the arm chainstitch sewing machine
 UN9588L-PF/ECV 3-needle, light
 UN9588-PF/ECV 3-needle, medium
 UN9588XH-PF/ECV 3-needle, heavy
 UN9578XH-PF/ECV 2-needle, heavy



UN9578-VPL-TK
 Double-needle high-speed collar tape sewing machine



UN-J9588-MPF/ECV
 Automatic feed off the arm chainstitch sewing machine - Economical type
 UN-J9588L-MPF/ECV 3-needle, light
 UN-J9588-MPF/ECV 3-needle, medium
 UN-J9588XH-MPF/ECV 3-needle, heavy
 UN-J9578XH-MPF/ECV 2-needle, heavy



UN928DD-XH-2PL
 3 needle, heavy with 2 pullers
 UN928DD-XH-PL 3-needle, heavy with 1 puller
 UN928DD-L-PL 3 needle, light with 1 puller
 UN927DD-PLB 2 needle, light with 1 puller



UN927DD-PS
 2-needle, heavy with PS puller
 UN928DD-L-PS 3-needle, light with PS puller
 UN928DD-XH-PS 3-needle, heavy with PS puller



UN928DD-L
 3 needle, light
 UN928DD-H 3 needle, heavy
 UN927DD 2 needle, light



Rubber Metal EPF VPL



UN35800DNU

Feed off the arm chainstitch sewing machine
 UN35800DNU Mechanical drive puller, differential feed
 UN35800DRU Mechanical drive puller, plain feed
 UN35800PZ Mechanical drive puller, plain feed with reversed teeth steel roller
 UN35800DZ Mechanical drive puller, differential or plain feed with reversed teeth steel roller



2-needle 3-needle

MULTI-NEEDLE SEWING MACHINE SERIES

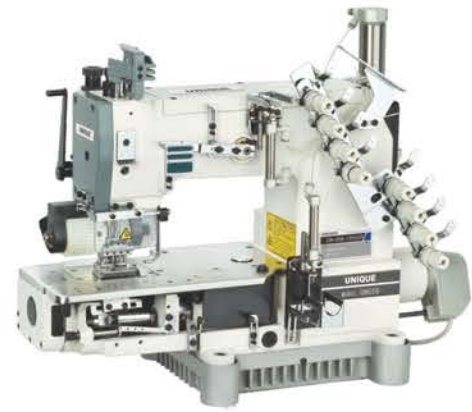

UN008-13032P-PUT

CYLINDER BED MULTI NEEDLE SEWING MACHINE (PNEUMATIC AUTO THREAD TRIMMER)

Pneumatic auto thread trimmer

UN008-04085P-PUT
UN008-08064P-PUT
UN008-12064P-PUT
UN008-13032P-PUT

Compare by making pant

- Save sewing thread
- Increase the working efficiency



Threads wastage of under trimming type
Under trimming: 12m/pair



Threads wastage of basic type
Basic type: 15.72m/pair

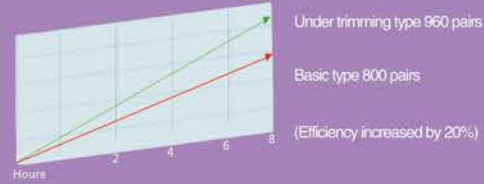

UN077C-12048-PUT
Belt type



UN008-65048P/VPQ/VSM
UN008-71048P/VPQ-T



UN008-118048P-S
Special smocking

UN008-08 064P-DD-VWL

08: Needle number
064: Gauge set
DD: Direct drive
VWL: Attachment

Rear puller

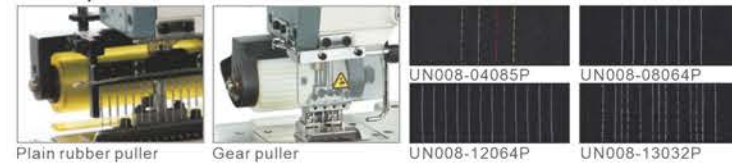

| Model | Needles | Stitch | Width | Length | Speed (S.p.m) |
|--------------|---------|--------|-------|---------|----------------|
| UN008-04048P | 4 | 8 | 3/16" | 1.4-3.6 | 12 11-14# 3500 |
| UN008-04064P | 4 | 8 | 1/4" | 1.4-3.6 | 12 11-14# 3500 |
| UN008-04080P | 4 | 8 | 5/16" | 1.4-3.6 | 12 11-14# 3500 |
| UN008-04085P | 4 | 8 | 1/3" | 1.4-3.6 | 12 11-14# 3500 |
| UN008-04095P | 4 | 8 | 3/8" | 1.4-3.6 | 12 11-14# 3500 |
| UN008-04106P | 4 | 8 | 3/7" | 1.4-3.6 | 12 11-14# 3500 |
| UN008-04127P | 4 | 8 | 1/2" | 1.4-3.6 | 12 11-14# 3500 |
| UN008-08064P | 6 | 12 | 1/4" | 1.4-3.6 | 12 11-14# 3500 |
| UN008-08048P | 8 | 16 | 3/16" | 1.4-3.6 | 12 11-14# 3500 |
| UN008-08064P | 8 | 16 | 1/4" | 1.4-3.6 | 12 11-14# 3500 |
| UN008-08085P | 8 | 16 | 1/3" | 1.4-3.6 | 12 11-14# 3500 |
| UN008-12032P | 12 | 24 | 1/8" | 1.4-3.6 | 12 11-14# 3500 |
| UN008-12048P | 12 | 24 | 3/16" | 1.4-3.6 | 12 11-14# 3500 |
| UN008-12056P | 12 | 24 | 7/32" | 1.4-3.6 | 12 11-14# 3500 |
| UN008-12064P | 12 | 24 | 1/4" | 1.4-3.6 | 12 11-14# 3500 |

| Model | Needles | Stitch | Width | Length | Speed (S.p.m) |
|------------------|---------|--------|-------|---------|----------------|
| UN008-13032P | 13 | 26 | 1/8" | 1.4-3.6 | 12 11-14# 3500 |
| UN008-13064P | 13 | 26 | 1/4" | 1.4-3.6 | 12 11-14# 3500 |
| UN008-16048P | 16 | 32 | 3/16" | 1.4-3.6 | 12 11-14# 3500 |
| UN008-17032P | 17 | 34 | 1/8" | 1.4-3.6 | 12 11-14# 3500 |
| UN008-18064P | 18 | 36 | 1/4" | 1.4-3.6 | 12 11-14# 3500 |
| UN008-23032P | 23 | 46 | 1/8" | 1.4-3.6 | 12 11-14# 3000 |
| UN008-23048P | 23 | 46 | 3/16" | 1.4-3.6 | 12 11-14# 3000 |
| UN008-25048P | 25 | 50 | 3/16" | 1.4-3.6 | 12 11-14# 3000 |
| UN008-25064P | 25 | 50 | 1/4" | 1.4-3.6 | 12 11-14# 3000 |
| UN008-33048P | 33 | 66 | 3/16" | 1.4-3.6 | 12 11-14# 2000 |
| UN008-50048P | 50 | 100 | 3/16" | 1.4-3.6 | 12 11-14# 1500 |
| UN008-50064P | 50 | 100 | 1/4" | 1.4-3.6 | 12 11-14# 1500 |
| UN008-65048P | 65 | 100 | 3/16" | 1.4-3.6 | 12 11-14# 1500 |
| UN077C-12064P-ZD | 12 | 24 | 1/4" | 1.4-3.6 | 12 11-14# 4300 |
| UN077C-13032P-ZD | 13 | 26 | 1/8" | 1.4-3.6 | 12 11-14# 4300 |

MULTI-NEEDLE SEWING MACHINE

TOPDIS

| Name | Machine Picture | Stitch Sample | Description | Model |
|---------|-----------------|---------------|--|--|
| VWL | | | Elastic-feeding for waist sewing | UN008-04085P/VWL UN008-08064P/VWL UN008-12032P/VWL |
| VPL | | | Tape attaching | UN008-08064P/VPL UN008-06064P/VPL |
| VSF | | | Shirt fronting attaching | UN008-0448-254P/VSF UN008-0464-191P/VSF UN008-0464-254P/VSF |
| VPT | | | Pin tucking | UN008-12048P/VPT UN008-12064P/VPT |
| VPQ-T | | | Single elastic thread shirring sewing (Elastic thread on top, no bottom thread) | UN008-12048P/VPQ-T UN008-12064P/VPQ-T UN008-13064P/VPQ-T UN008-16048P/VPQ-T UN008-18064P/VPQ-T UN008-23048P/VPQ-T UN008-25048P/VPQ-T UN008-25064P/VPQ-T UN008-33048P/VPQ-T UN008-50048P/VPQ-T UN008-50064P/VPQ-T UN008-65048P/VPQ-T |
| VSQ | | | Bottom elastic thread shirring sewing (Elastic thread on bottom, normal thread on top) | UN008-12048P/VSQ UN008-12064P/VSQ UN008-13064P/VSQ UN008-16048P/VSQ UN008-18064P/VSQ UN008-23048P/VSQ UN008-25048P/VSQ UN008-25064P/VSQ UN008-33048P/VSQ UN008-50048P/VSQ UN008-50064P/VSQ UN008-65048P/VSQ |
| VPQ/VSM | | | Single elastic thread shirring sewing and smocking (Elastic thread on bottom, smocking effect) | UN008-12048P/VPQ/VSM UN008-12064P/VPQ/VSM UN008-13064P/VPQ/VSM UN008-16048P/VPQ/VSM UN008-18064P/VPQ/VSM UN008-23048P/VPQ/VSM UN008-25048P/VPQ/VSM UN008-25064P/VPQ/VSM UN008-33048P/VPQ/VSM UN008-50048P/VPQ/VSM UN008-50064P/VPQ/VSM UN008-65048P/VPQ/VSM |
| VSQ/VSM | | | Bottom elastic thread shirring sewing and smocking (Elastic thread on bottom, normal thread on top, smocking effect) | UN008-12048P/VSQ/VSM UN008-12064P/VSQ/VSM UN008-13064P/VSQ/VSM UN008-16048P/VSQ/VSM UN008-18064P/VSQ/VSM UN008-23048P/VSQ/VSM UN008-25048P/VSQ/VSM UN008-25064P/VSQ/VSM UN008-33048P/VSQ/VSM UN008-50048P/VSQ/VSM UN008-50064P/VSQ/VSM UN008-65048P/VSQ/VSM |

Multi-needle chainstitch sewing machine

Direct drive cylinder bed with pneumatic thread trimmer and foot lifter

- UN4404P-DD-PUT 4 needles 1/4 3/16
- UN4406P-DD-PUT 6 needles 1/4 3/16
- UN4408P-DD-PUT 8 needles 1/4 3/16
- UN4412P-DD-PUT 12 needles 1/4 3/16
- UN4413P-DD-PUT 13 needles 1/4 3/16
- UN4418P-DD-PUT 18 needles 1/4 3/16
- UN4423P-DD-PUT 23 needles 1/4 3/16
- UN4425P-DD-PUT 25 needles 1/4 3/16

| Cylinder-bed | Needles | Gauge |
|--------------|---------|---------------------------------|
| UN4404P | 4 | 1/4 1/3 5/16 3/8 |
| UN4406P | 6 | 1/4 3/16 |
| UN4408P | 8 | 1/4 3/16 |
| UN4412P | 12 | 1/4 3/16 1/8 |
| UN4413P | 13 | 1/4-1/8-1/8-1/4 triple flexible |
| UN4418P | 18 | 1/4 |
| UN4423P | 23 | 1/4 |
| UN4425P | 25 | 3/16 |

| Flat-bed | Needles | Gauge |
|----------|---------|---------------------------------|
| UN1404P | 4 | 1/4 5/16 1/3 3/8 |
| UN1406P | 6 | 1/4 3/16 1/8 |
| UN1408P | 8 | 1/4 3/16 1/8 |
| UN1412P | 12 | 1/4 3/16 1/8 |
| UN1413P | 13 | 1/4-1/8-1/8-1/4 triple flexible |
| UN1417P | 17 | 3/16 1/8 |
| UN1418P | 18 | 1/4 |
| UN1423P | 23 | 1/8 |
| UN1425P | 25 | 1/4 |
| UN1433P | 33 | 3/16 1/8 |
| UN1450P | 50 | 3/16 |

*All belt type can be upgraded to direct drive model like UN1412P-DD

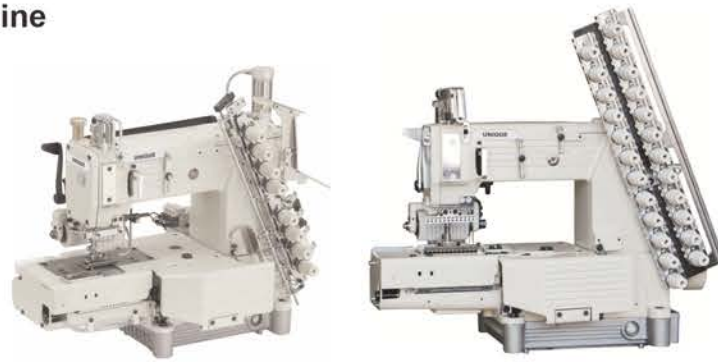

UN4413P-DD-PUT

UN4412P



UN1412P

UN1425P



UN1450P-DD
Ultra multi needle chainstitch sewing machine



UN1112P-DD-L
12 needle, needle feed



UN1402P-DD-ZP
For zipper



UN-8-4
Fully automatic hat sweatband machine (NEW model)
UN-8-3



UN008-13032P-VPL-SDK
Fully automatic for tape attaching

| Name | Machine Picture | Stitch Sample | Description | Model |
|-------------------|-----------------|---------------|---|--|
| PMD | | | Elastic-feeding for waist sewing | UN1404PMD UN4404PMD UN1406PMD UN4406PMD UN1408PMD UN4408PMD UN1412PMD UN4412PMD UN1413PMD UN4413PMD |
| PL | | | Tape attaching | UN1406PL UN4406PL UN1408PL UN4408PL UN1412PL UN4412PL |
| PSF | | | Shirt fronting attaching | UN1404PSF |
| PTV PSM-PTV | | | Pin tucking | UN1412PTV UN1412PSM-PTV |
| PS | | | Single elastic thread shirring sewing, (Elastic thread on top, no bottom thread) | UN1012PS UN1412PS UN1017PS UN1417PS UN1025PS UN1425PS UN1033PS UN1433PS UN1050PS UN1450PS UN1066PS UN1466PS |
| PQ PQSM | | | PQ: Elastic thread in middle, regular thread on top and bottom PQSM: Smocking effect, regular thread on top, regular thread and elastic thread on bottom | UN1412PQ UN1412PQSM UN1417PQ UN1417PQSM UN1425PQ UN1425PQSM UN1433PQ UN1433PQSM |
| PS-ET PS-ET-MD | | | Bottom elastic thread shirring sewing (Elastic on bottom, regular thread on top) | UN1012PS-ET UN1412PS-ET UN1017PS-ET UN1417PS-ET UN1412PS-ET MD UN1417PS-ET MD |
| PTF PSM | | | PTF: 3 needle chain stitch for lap seaming PSM: 3 needle chain stitch with different type smocking | UN1503PTF UN1403PSM |
| PSSM PSSM-MD | | | PSSM: Smocking effect, elastic on top, no bottom thread PSSM-MD: Smocking effect, regular thread on top, elastic thread on bottom | UN1012PSSM UN1425PSSM-MD UN1017PSSM UN1433PSSM-MD UN1025PSSM UN1438PSSM-MD UN1033PSSM UN1450PSSM-MD UN1038PSSM UN1050PSSM UN1412PSSM UN1417PSSM |

Waist-band sewing machine

UN1508 P R D-DD-P

Heavy duty waist banding machine
1508: 4-needle
1509: 6-needle

R: Split bottom puller
(Better adjust for curve waistbanding)

DD: Direct drive

P: back puller

D: Split UP puller
(Better adjust for curve waistbanding)

P: Auto foot lifting



UN1508PRD



UN1508PRD-DD-A

With skip stitch function

Needle-feed waist-band sewing machine

UN1104 P R D-DD-P(UTC)

Needle feed heavy duty waist banding machine
1104: 4-needle, needle feed
1105: 5-needle, needle feed
1106: 6-needle, needle feed

P: back puller

DD: Direct drive

R: Split bottom puller
(Better adjust for curve waistbanding)

P: Auto foot lifting

D: Split UP puller
(Better adjust for curve waistbanding)

UTC: Auto curve stitch, auto skip stitch, auto fabric cut
PTC: Adjustable folder, curve stitch control by foot presser, skip stitch control by manual



UN1104P-DD

Needle feed waist band sewing machine



UN1104PRD-DD-P(UTC)

Automatic needle feed waist band sewing machine with auto skip stitch, auto fabric cutting and auto curve waistband



UN1104PRD-DD-P(PTC)

Needle feed waist band sewing machine with manual skip stitch



UN8752E-BTC

Multifunctional double-needle lockstitch sewing machine for waistband attaching



UN2000C-DD-A

Belt loop forming and rolling machine
Especially good for UN254 belt loop attaching machine



UN562DD-04-MTK

Belt-loop sewing machine

UN562-04 With knife
UN562DD-04 Direct drive, with knife
UN562-04-ATK With knife and tape cutting
UN562DD-04-MTK Direct drive, with knife and tape cutting



UN2000C

Belt-loop sewing machine

UN2000C With knife
UN2000CP With knife and puller
UN2000C-TK With knife and tape cutting
UN1702 Without knife
UN1702PMD With elastic feeding device

>>Optional>>

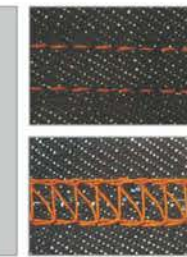

UN-LT1080
Belt loop trimmer



UN430D-154

Automatic 1-needle belt loop setter



UN254

Automatic 2-needle belt loop attaching machine
(Automatic cutting, feeding, folding)

UN254-L For thin material





UN-2210TB-AF
Electronic pattern sewing machine for label attaching with auto feeding device
Label size max 90*70mm; min 40*25mm



UN-1310TB
Electronic pattern sewing machine for label attaching
Max stitch size 13*10cm



UN-2210G-DH-AFC
Electronic pattern sewing machine for pocket decorative stitches



UN2210G-DH
Electronic pattern sewing machine for pocket decorative stitches
UN-2210G-DH 1 needle
UN-2210G-DH-AFC With automatic pocket feeding and collecting
UN-2210G-DH 2 needles 2 colors



UN-7103WB
Automatic waistband folding and sewing machine (imitation hand-made)



UN3020G-MJ
Electronic pattern sewing machine for jean's J stitch
30*20cm



UN-858K-DK
Automatic jeans back pocket hemming machine with 2 needle chainstitch type with interlock machine head



UN-8720-5-DK
Automatic jeans back pocket hemming machine
2-needle lockstitch type



UN-3883P-PLB-DK
Automatic jeans back pocket hemming machine
2-needle chainstitch type



UN63900ABH
Fully automatic lockstitch bottom hemming machine



UN63972
Automatic jeans bottom hemming machine with lockstitch & chainstitch exchangeable
UN63970 Lockstitch type only
UN63971 Chainstitch type only



UN63902-WH
Automatic jeans bottom hemming machine with lockstitch & chainstitch exchangeable with max hemming width up to 10cm



UN9820-01
Electronic eyelet button holing machine



| Specifications | UN9820-00 | UN9820-01 | UN9820-02 |
|----------------------|--|-------------------------------|------------------|
| Upper thread trimmer | Long thread cut | Long thread cut | Short thread cut |
| Lower thread trimmer | None | Long thread cut | Short thread cut |
| Main applications | Ladies' wear | Men's wear, casual wear | Jeans, trousers |
| Other applications | Men's wear, casual wear, jeans, trousers | Ladies' wear, jeans, trousers | |
| Sewing shape | | | |



UN9820-02-AMF
Electronic eyelet button holing machine with auto feeder



UN580-121
Electronic eyelet button holing machine
Better for western-style clothes and lady coat

- UN580-121 Basic type
- UN580-121Z With thread grab device (For better stitch)
- UN580-122 Basic type
- UN580-141 Thread short cutter for Jeans
- UN580-321 Eyelet hole with multi times cutting, with thread grab device
- UN580-112 Thread short cutter, with thread grab device
- UN580-312 Eyelet hole with multi times cutting, with thread grab device, thread short cutter

UN6000S
Computerized imitation buttonhole sewing machine-Straight and slant
Eyelet length: 15mm--25mm



UN6000D Straight type



UN1790E
Electronic straight button holing machine



UN1790-L02
Automatic button holing machine



UN1790-BA
Automatic button holing machine
For horizontal and vertical button holing



UN781E-2S
Direct drive straight button holing machine with 2 step motors
1 step motor for auto foot lifter and the another for silent button hole cutting without slowing working speed
UN781E-1S With 1 step motor for foot lifter



UN781N-2S
Direct drive straight button holing machine with 2 step motors
1 step motor for auto foot lifter and the another for silent and non-stop button hole cutting.
UN781N-1S With only 1 step motor for foot lifter



UN781E
Direct drive straight button holing machine
UN781E 6.35mm---19.5mm
UN782E 6.35mm---25.4mm
UN783E 6.35mm---31.8mm
UN781E-NV For Sweater



UN-B781
Straight button holing machine
UN-B781 6.35mm---19.5mm
UN-B782 6.35mm---25.4mm
UN-B783 6.35mm---31.8mm
UN-B781NV For Sweater

- Multiple-times knife dropping
- Easy changeover of sewing setting
- Basting stitch on elastic materials
- Main functions driven electrically



Optional: Long arm presser

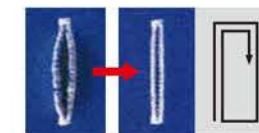

Basting stitch



Option: Automatic fabric feeding device



SK
Flat button automatic feeding device



LK
Shank button automatic feeding device

UN1903ASS SK-P -

Adaptive models:
UN1377DD
UN1373S
UN438D

SK-E: Flat button, electric
SK-P: Flat button, pneumatic

/: Standard
CR: Color Recognition
VR: Visual Recognition

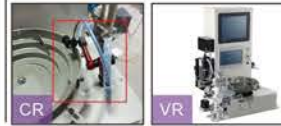

UN373DD-LK -

Adaptive models:
UN4-2D
UN1373S
UN438D
UN1903ASS

LK: Shank button

/: Standard
VR: Visual Recognition



UN1903ASS
Electronic button sewing machine (Lockstitch)



UN438D
Electronic button sewing machine (Lockstitch)

Button stitch patterns

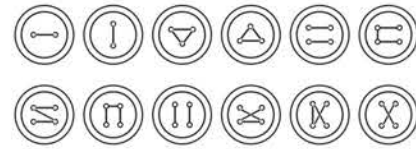

Optional:



UN1373S
Step motor integrated presser foot button sewing machine



UN1377DD
Direct drive button sewing machine (Chainstitch)
UN1377DD ○○○○ UN373DD ○○○○ UN373DDX ○○○○



UN4-2D
Electronic Button Sewing Machine (For Vertical Buttons)

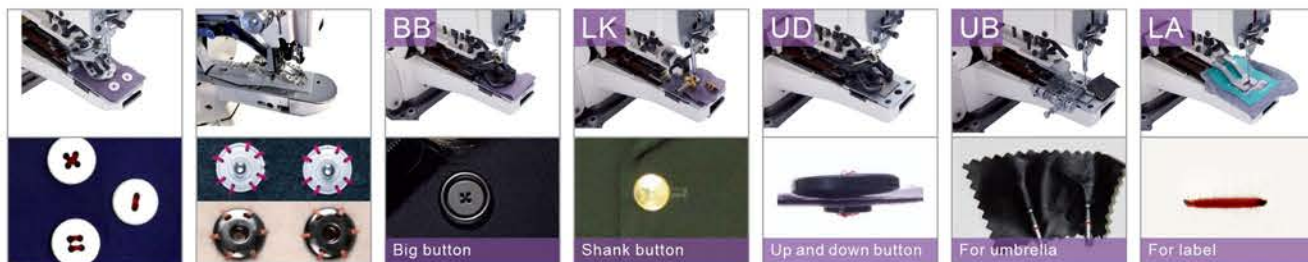

UN1903ASS-SK-P
Electronic button sewing machine with auto button feeder



UN373DD-LK
Shank button attaching machine with auto button feeder
UN373DD-LK with UN373DD machine head
UN1903ASS-LK with UN1903ASS machine head
UN438D-LK with UN438D machine head



UN1903ASS-L01
Automatic button attaching machine with auto fabric feeding and button feeding
1-20 pcs of buttons can be set.
Distance between the first and last button 655mm
Suitable for shirt



UN1903ASS-BA
Automatic button attaching machine with auto fabric feeding and button feeding
1-5 pcs of buttons can be set.
Distance between each button 20-100mm
Suitable for polo-shirt



UN438D-BS
Electronic button sewing machine with blind seam on backside
For suit the backside seam is invisible
For shirt the backside seam is neat without bird nest



UN-289
Computerized single thread chainstitch button-neck wrapping machine

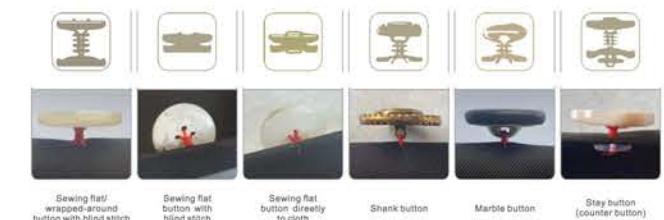



Automatic snap button machine



- UN9918
 - AB Snap button - cover
 - CD Snap button - bottom
 - CD-S Snap button with auto gasket filling
 - R Revit decorative button
 - E Eyelet button
- UN9918
 - J Jeans button
 - Z Bump button



UN9918



UN9196 Automatic snap button attaching machine



UN9828 Automatic snap button machine
It can recognize a series of button image recognition such as letters, special-shaped patterns, striped plaid LOGO, etc.



UN9813



UN9028 Automatic snap button machine



UN9896 Automatic snap button machine for trousers hook



UN-T3 Direct drive snap button attaching machine with 3-head
UN-T3 electric type
UN-838Q pneumatic type



UN-T1 Direct drive snap button attaching machine



UN-818D Economical direct drive snap button attaching machine



UN-838T-360 360° direct drive snap button attaching machine with 3-head



UN-T1-DSA Semi-automatic eyelet snap button attaching machine



UN-Q1-S Pneumatic snap button attaching machine with protection device



UN808 Snap button attaching machine



UN-B686 Automatic button wrapping machine



UN-3680A Cap button attaching machine



UN-MF2/UN-MH1 Manual snap button machine
UN-MF2 2 head
UN-MF1 1 head
UN-MH1



UN-6-1 Auto cover button machine



UN-TM7001 Lable staple attaching machine



UN-TM2001 Lable staple attaching machine



UN-500 Plastic staple attaching machine



UN-TM5209 Lable staple attaching machine for socks



UN-LS-01 Pneumatic loop label sewing machine



UN-LS-08 Pneumatic loop label sewing machine



UN430D
Electronic bar tacking machine
UN430HD heavy duty

>>Optional



Touch panel

40*30mm presser foot



Button sewing clamp:

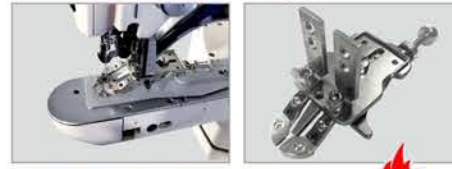

UN1900BSK/UN430BSK:
Bar tacking & Button sewing in one machine



Different presser foot:



UN436D-P
Electronic bar tacking machine
with 90*60mm pattern with
pneumatic clamp pressing & height adjustable press foot
UN436D Clamp pressing by electromagnet



UN1906ASS UN1906ASS: 60*52mm UN1906ASS-J: For Elastic joining
Electronic bar tacking machine with 60*52mm



UN430D-TX
Electronic bar tacking machine
with thread trimming



Before After

Especially good for bar tacking and thread trimming on 4 needle 6 thread interlock seam



UN1850D
Direct drive bar tacking machine
UN1850 Basic
UN1850D Direct drive



UN326G-AVCA
Automatic velcro tape cutting and attaching machine
with top feeding with max. tape size 20*10cm
UN342G-AVCA with max. tape size 30*20cm
UN436D-AVCA with max. tape size 9*6cm
UN430D-AVCA with max. tape size 4*3cm



UN436D-AVCB
Automatic velcro tape cutting and attaching machine
with bottom feed with max. tape size 9*6cm
UN342G-AVCB with max. tape size 30*20cm
UN326G-AVCB with max. tape size 20*10cm
UN430D-AVCB with max. tape size 4*3cm

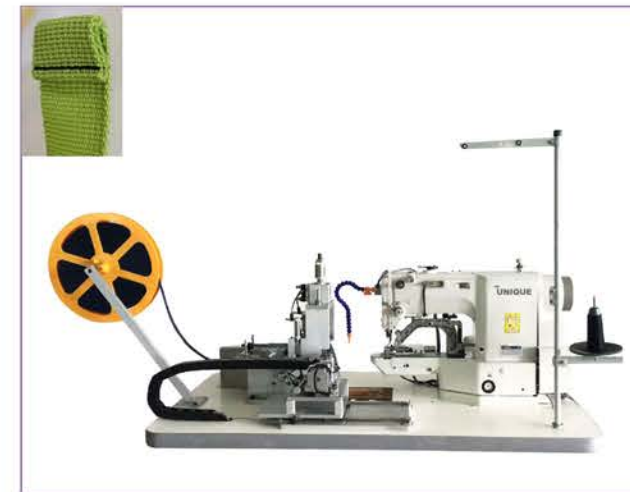

UN430D-ATF-A
Full automatic ribbon belt folding and bartacking machine
with auto tape feeding and cutting



UN430D-ATF
Electronic ribbon belt folding and bartacking machine



UN-F136
Crotch reinforcement tape attaching machine



UN-F204
Automatic shoulder strap sewing machine



UN2210-20
Electronic eyelet hole punching and sewing machine
Max hole diameter 6mm



UN430D-O
Electronic eyelet punching and sewing machine
Max hole diameter 9mm



UN430-ABN
Anti-bird's nest electronic knotting machine



UN430D-BL
Electronic bar tacking sewing machine for attaching belt loop



UN430D-O-2
Double station electronic eyelet hole punching and tacking machine



UN430D-OST-2
Electronic eyelet hole punching and tacking machine with 2-stations with lining reinforcement



UN430D-SODW-2
Double station electronic eyelet hole tacking sewing machine with pneumatic positioning



UN430E-ST
Electronic eyelet hole tacking machine with auto lining reinforcement



UN430D-I
Oval eyelet hole tacking machine with straight blade cutter



UN3520-O
Electronic large eyelet hole punching and tacking machine



UN430D-ZSOT
Electronic eyelet hole punching and tacking machine with auto feeding lining device



UN1254-3
Electronic bar tacking machine with lifting head for cushions
UN1254-3 Lifting height 117 mm, cushion diameter 560 mm
UN1254-2 Lifting height 110 mm, cushion diameter 480 mm



UN301542-1
Electronic pattern sewing machine with lifting head for cushions
UN301542-1 Lifting height 150 mm, cushion diameter 840 mm
UN301542-1H Lifting height 250 mm, cushion diameter 840 mm



UN301542-2
Electronic pattern sewing machine with lifting head for sea cushions
UN301542-2 Lifting height 150 mm, cushion diameter 840 mm



UN-1012A
Backpack triangle unit



UN-BSJ
16 Spindles high speed braider

Optional devices

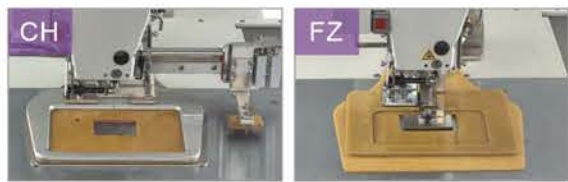

CH Sliding clamp device

FZ Flip flop device



MY Hat shape presser foot

HM Template changeable device



UN326G
Electronic pattern sewing machine

UN311G 130mm*100mm
UN326G 220mm*100mm



UN342G
Electronic pattern sewing machine

UN342G 300mm*200mm
UN4530G 450mm*300mm



UN6040G
Electronic pattern sewing machine

UN6040G 600mm*400mm



UN1010G-SC
Cylinder bed pattern sewing machine

UN1010G-SC 100mm*100mm
UN1510G-SC 150mm*100mm
UN1010G-SC-AF 100mm*100mm AUTOMATIC FEED
UN1510G-SC-AF 150mm*100mm AUTOMATIC FEED

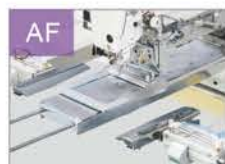

UN210E-2210
Electronic pattern sewing machine

UN210E-2210 220*100mm
UN221E-3020 300*200mm
UN224E-6040 600*400mm



UN-M3020G
Electronic pattern sewing machine

Presser foot controlled by motor with height adjustable
UN-M3020G 300*200mm UN-M5030G 500*300mm
UN-M3525G 350*250mm UN-M6040G 600*400mm
UN-M4030G 400*300mm

*All models have economical R model with pneumatic control presser foot like UN-M3020R



UN-M3020G-3LG
Electronic pattern sewing machine with 30*20cm, 3 times capacity hook
UN-M3020G-6LG 6 times capacity hook



UN-M6040G-6LG
Electronic pattern sewing machine with 60*40cm, 6 times capacity hook



UN-MC3020G
Electronic cylinder-bed pattern sewing machine

Presser foot controlled by motor with height adjustable
UN-MC3020G 5*20cm
UN-MC3040G 5*40cm





UN1008-311-9T
Full automatic pocket welting machine with laser cutter and auto pocket folding

Pocket size with length of 100-220mm, width of 10-35mm



UN1008-9D-PLUS
Full automatic pocket welting machine with laser cutter and auto pocket folding

Pocket size with length of 100-330mm, width of 10-35mm



UN-P895
Automatic pocket welting sewing machine

UN-P895 for straight pocket and flap - men's suits and trousers
UN-P896 for straight and slant pocket and flap - lady's suits and jackets



UN-4020G-PL
Placket sewing machine with oscillating blade

UN-4020G-PO Pocket opening



UN-A02AF
Automatic placket opening machine for polo shirt with auto feeding



UN-PS3520F
Pocket welting and placket opening machine with laser cutter

Sewing area: 350*200mm, laser cutting area: 210*195mm



UN-PFC988S-01
Pocket flap and collar sewing machine with laser trimming



UN-6112MD
Computerized automatic bar tacking and button attaching machine

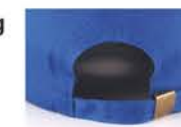

UN-PS326F
Pocket welting and placket opening machine with laser cutter

Sewing area: 220*110mm, pocket max length 220mm



UN-PL8000A
360 rotary knife placket sewing machine with oscillating blade



UN-RK200P
Automatic rope end knotting and sealing machine

Optional Mitsubishi-style Machine Head



UN-311-TD-S
Full-automatic pocket setter machine for small pocket
Within size of 12*12cm



Optional Lockstitch Machine Head



UN-720-TD
Automatic pocket folding and setting machine (iron free)



UN-220-TD
Automatic pocket folding and setting machine (iron free)
2 head 2 color



UN-155-TD
Automatic pocket setting machine



UN-163-TD
Automatic pocket setter for kangaroo pocket
With size of 50*30cm



UN-320-TD-AP
Automatic accordion pocket setter



UN-MY342
Semi automatic cap visor sewing machine



UN2116
Semi automatic curved visor sewing machine



UN2116-2
Full automatic curved visor sewing machine -double head



UN2116-A
Full automatic curved visor sewing machine -single head



UN430D-ACE
Automatic cap eyelet sewing machine (automatic feeding)



UN-XH01
Automatic cap eyelet sewing & stitching machine (Front piece)

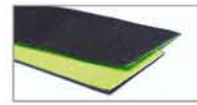

UN-A200P-U-VR
Full automatic elastic joining machine with auto feeding, ultrasonic cutting and visual recognition
Auto over-knotting and length metering
Max. elastic width: 7cm
Min. elastic circumferences: 20cm



UN-A200P-X
Full automatic elastic joining machine with auto feeding, cutting and logo positioning
Auto over-knotting and length metering
Max. elastic width: 7cm
Min. elastic circumferences: 20cm

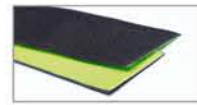

UN-A200B-U
Full automatic elastic joining machine with auto feeding, ultrasonic cutting and logo positioning
Auto over-knotting and length metering
Max. elastic width: 5cm
Min. elastic circumferences: 20cm
UN-A200B-X with knife cutting



UN-A280B-U-VR-W
Full automatic elastic joining machine with auto feeding, ultrasonic cutting and visual recognition
Suitable for premium underwear: ultrasonic circular welding + sewing

The efficiency of a double-head machine only starts to surpass that of two single-head machines when it has more than 180 stitches.



Double head flat joint

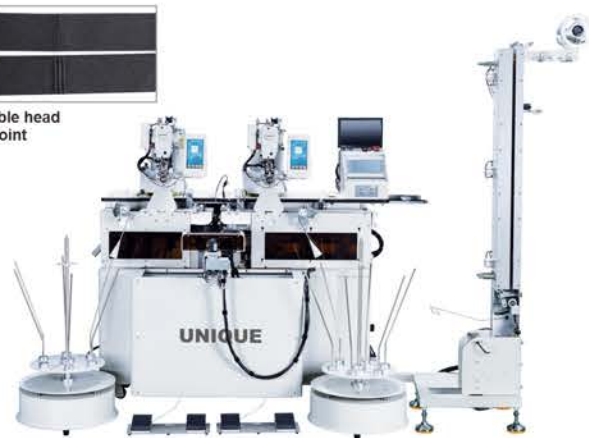

UN-A300P-2-U-VR
Full automatic double-station elastic joining machine with auto feeding, ultrasonic cutting and visual recognition
Auto over-knotting and length metering
Max. elastic width: 7cm
Min. elastic circumferences: 20cm



UN-C70-U-VR-W
Automatic elastic tape cutting machine with visual recognition with circular welding function
UN-C70-U-VR-SD With auto stacking but without circular welding function
UN-C70-U Basical model



UN-3AC
Fully automatic three-clip collar sewing and cutting machine



UN113A
Automatic sleeve placket setter



UN-5017A
Shirt pocket hemming machine



UN-6061
French seam sewing machine



UN113B
Sleeve placket creaser



UN-PC94
Shirt placket cutting machine



UN-250Q
Automatic bra hook eye attaching sewing machine

UN-230G
Automatic bra hook eye attaching sewing machine



UN-800D
Automatic bra shoulder strap sewing machine



UN-GLK-JD00B-01
Semi-automatic strap make machine



UN-GLK-CSB
Ultrasonic back button microtome



UN2210G-BQ
Automatic hook and eye sewing machine (For bra)



UN-PFJ400
Multifunction curtain hemming machine



UN-AFJ400
Computer curtain blind stitch machine



UN-DXJ300-31
Computer automatic curtain vertical heat setting machine



UN-YBJ300
Curtain inspection machine (LED)



UN-RA98F
Automatic curtain ring attaching machine



UN-CGJ40X30
Computer curtain final height cutting machine



UN-DZJ103
Computer automatic curtain pleating machine



UN-HBJ100
Computer multi-needles curtain sewing machine



UN364-7-P
Direct drive differential feed blind stitch sewing machine with auto trimmer, and auto foot lifting
UN364-DD Motor built on backside



UN101DD
Direct drive blind stitch sewing machine
UN101DD-H For heavy duty
UN101D-7-P With auto trimmer, and auto foot lifting



UN101DD-7-P
Direct drive differential feed blind stitch sewing machine



UN500-1
Blind stitch sewing machine - desktop type
UN500-1 With skip stitch
UN500-3 Without skip stitch
UN500H-1 With skip stitch



UN140DD
Direct drive cylinder bed blind stitch sewing machine
UN140-7-P With auto trimmer, and auto foot lifting



UN360DD
Blind stitch sewing machine
UN360DD Direct drive, for light duty
UN361DD Direct drive, for heavy duty
UN360-7-P With auto trimmer, and auto foot lifting



UN357-DD
Direct drive blind stitch sewing machine (Trousers waist blind stitch)
UN357-7-P With auto trimmer, auto foot lifter



UN860-10
Blind stitch sewing machine (for trousers belt loop)



UN370DD-T
Direct drive belt loop blind stitch sewing machine - with knife, width adjustable
UN370DD Direct drive



UN813DD
Blind stitch sewing machine - for light material
UN813-7-P With auto trimmer, and auto foot lifting



UN1430DD
Blind stitch sewing machine - belt feed
UN1430-7-P With auto trimmer, and auto foot lifting
UN2430DD Double thread



UN-B1190DD
Blind stitch sewing machine - double face blind stitch
UN-B1190DD Direct drive
UN-B1190DD-H For heavy duty
UN-B1190-7-P With auto trimmer, and auto foot lifting



UN100-4
Direct drive blind stitch sewing machine for roll hemming
UN100-4-P Direct drive with auto foot lifting
UN100-5 For book seam



UN170S
Direct drive blind stitch sewing machine - double thread with lockstitch



UN170-22D
Direct drive blind stitch sewing machine - durable and versatile
UN170-22D-7-P With auto trimmer, and auto foot lifting



UN200-2
Single thread double blind stitch machine



UN100-3
Single thread blind stitch machine for waistband linings



- Overstitch tacking
- Auto trimmer
- Auto foot lifting

UN160-30
Computerized single thread spot tacking blind stitch



UN218D-TP-R
Two thread blind stitch sewing machine for felling under-collars



UN325-40D-TP
Two thread blind stitch machine for armhole lining



UN328D
Two thread blind stitch machine for sleeve lining



UN58-4D
Single thread blind stitch machine for lapels and chest interlinings



UN710
Two thread blind stitch sewing machine for lining felling of jackets/coats
Un718 For under-collars



UN-810C
Two thread blind stitch sewing machine



UN657
Computerized sleeve setting machine

1. Belt drive(protect the fabric)
2. Fabric feeding by 4 motor
3. More than 100 setting program
4. 30 ruffling values provided
5. Thread tension control by computer
6. 2 different setting program working



UN697-24155
Post bed lockstitch sewing machine for shoulder pad

- Feeding type:
feed dog, needle feed, presser foot differential feed
- UN697-15155
UN697-24155 With cut



UN333N
Computerized cylinder bed basting machine for shoulder pad

1. Auto trimmer
2. Single needle tacking by pedal
3. Thread tension adjustable



UN8670
Computerized sleeve setting machine



UN688
Post bed lockstitch machine for shoulder pad



UN1243N
Computerized flat bed basting machine

1. Auto trimmer, auto foot lifting,
2. Special for lacking and basting of jackets, overcoats
3. Single needle tacking by pedal
4. Thread tension adjustable

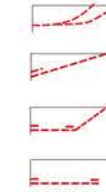

UN-EM2030
Automatic trousers dart and waistband pleat sewing machine

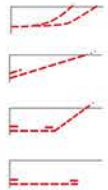

UN-9407
Automatic trousers dart and waistband pleat sewing machine



UN-DK-21
Automatic front pocket sewing machine (with trouser fly sewing function)

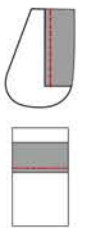

UN-9307
Automatic pocket flap folding & sewing machine for trousers
To fold and sew pocket facings to back or front pockets.



UN-KA-ED
Single thread roll-padding machine



UN550-5
Optimized workstation for stitching waistbands of skirts and trousers

Double face woolen coat sewing machine



UN-DF360/313



UN-DF360D/313D

- Speed adjustable
- Stitch distance adjustable
- Better for heavy and light material



For edge sewing
UN-DF360
UN-DF360D



For joining sewing
UN-DF313
UN-DF313D



UN-F2610F-DD
For double face woolen coat



UN-235-7H

Multifunctional fabric piping & bonding machine with electric ironing



UN-235-7J

Multifunctional fabric piping & bonding machine with steam ironing



UN9800EC

Direct drive placket edge cutting machine



UN-H351A

Decorative hand stitch sewing machine



UN-H781

Computerized hand stitch sewing machine

1. Auto trimmer
2. Thread tension is adjustable
3. Stitch length is adjustable



UN-H785

Computerized hand stitch sewing machine

1. Touch panel
2. Pattern stitch length is programmable
3. Thread tension is adjustable
4. Back reversing
5. Digital stitch size
6. Back tack on sewing end
7. Corner thread unhooking device



UN-H786

Computerized hand stitch sewing machine with micro oil lubrication



MP500

Chain shape hand stitch sewing machine

1. Auto trimmer
2. Stitch length is adjustable in 1.5mm, 2.0mm, 2.5mm
3. Thread tension is adjustable



MP301

Chain shape hand stitch sewing machine

1. Auto trimmer
2. Stitch length is adjustable in 1.5mm, 2.0mm, 2.5mm



UN-H388DD

Direct drive chain shape hand stitch sewing machine



UN-H0303DD

Direct drive walking foot chain shape hand stitch sewing machine



UN-H388D-B

Chain shape hand stitch sewing machine



UN-H388D-A Slanted
UN-H388D-B Horizontal



UN388

Chain shape hand stitch sewing machine

UN388-A Diagonal stitch
UN388-B Horizontal stitch



Computerized Basic
Horizontal Diagonal

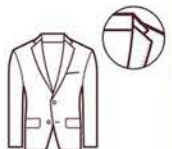



EXL5214DD-EUT / EX5214DD-EUT
Both side overlock sewing machine



EXTL5214DD-EUT / EXT5214DD-EUT
Both side differential feed overlock sewing machine



GCL9900-D4 / GC9900-D4
Both side lockstitch sewing machine



UN-L3800DD-2 / UN3800DD-2
Both side chainstitch sewing machine



GKL562-01CB-EUT / GK562-01CB-EUT
Both side flat bed interlock sewing machine



UN-L1503PTF-DD / UN1503PTD-DD
Both side flat bed multi needle chainstitch sewing machine



UN-L4404P-DD / UN4404P-DD
Both side cylinder bed multi needle chainstitch sewing machine



UN-L008-12064D / UN008-12064D
Both side multi needle sewing machine



GNL2502K-DD / GN2502K-DD
Both side carpet overlock sewing machine

DN-2LHS / DHL-HS
1 needle 2 thread chainstitch sewing machine
DN-2LHS Left side
DHL-HS Right side
Stitch length: 7-12mm
Thickness: 8mm

GK-L3700F / GK-3700F
Cylinder bed bag carpet fringing & over edging machine
GK-3700B For bag 1 needle, 2 thread
GK-3700F For carpet 2 needle, 4 thread



GN-5214-LR1
Full automatic overlock sewing machine with 1 left + 1 right

GN-5204-LR 3 thread
GN-5214-LR 4 thread
GN-3216-LR 5 thread



GN-5214-LR
Full automatic overlock sewing machine with 1 left + 1 right

GN-5204-LR 3 thread
GN-5214-LR 4 thread
GN-3216-LR 5 thread



UN-HN601
Pneumatic headscarf single-side overlock sewing machine



UN-RF602
Pneumatic reflective tape overlock sewing machine



UN-MT603
Automatic dual-side sewing & cutting machine for mattress & pillow covers



UN-VL604
Pneumatic velcro reflective tape overlock sewing machine

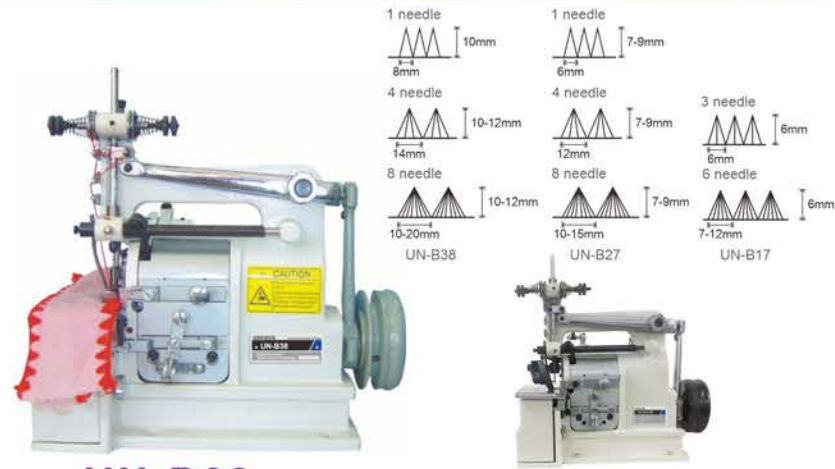

UN-B38

Shell stitch overlock sewing machine
 UN-B38 Big shell 1, 4, 8 stitches
 UN-B27 Medium shell 1, 4, 8 stitches
 UN-B17 Small shell 3, 6 stitches
 After change the different cam,
 UN-B17 model also can be made 1, 2 stitches

UN-B38-RF
Shell stitch overlock sewing machine with puller
 UN-B38-RF
 UN-B27-RF
 UN-B17-RF



UN-B18

Crochet overlock sewing machine
 UN-B18-5 Both side "I" shape with 5mm stitch
 UN-B18-10 Both side "I" shape with 10mm stitch (11/12/13/14mm stitches also can be customized)
 UN-B28-5 One side "I" shape and one side "▲" with 5mm stitch
 UN-B28-10 One side "I" shape and one side "▲" with 10mm stitch (11/12/13/14mm stitches also can be customized)



UN1302-4W
Picotting machine for fagotting zigzag 4 point

UN1302-5W Fagotting zigzag 5 point
 UN1303 Fagotting
 UN1301-4-3F 3 step 4 point
 UN1301-2F 2 step 3 point



UN1721PK
Picotting sewing machine with knife and puller

UN1721 Basic
 UN1721K With knife
 UN1721P With puller
 UN1721PK-A Auto oiling system
 UN1721PKAT Auto oiling system and turning stitch



UN1238DD
Picotting sewing machine



UN1228
Double color floral rope machine



UN1828
8 stitch sewing machine



UN271/391
Embroidery sewing machine with zigzag function

UN271 Without presser foot
 UN391 With presser foot



GY10-2
Embroidery sewing machine

GY10-2 5 Kinds of stitches
 (Chain, moss, taping, braiding, ray)



GY10-1
Embroidery sewing machine

GY10-1 2 kinds of stitches(Chain, moss)
 GY10-4 3 kinds of stitches(Chain, moss, taping)



UN-B990
Shell pattern thread adjuster



UN-E1760
Emblem overlock sewing machine

UN-B30S Small shell stitch
 UN-F20 Fishbone stitch

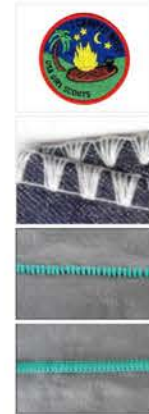

UN-BS1-2
Blanket overlock sewing machine



UN-B9870-7
Computerized basting machine with auto trimmer

UN-B9870W-7 Walking foot with auto trimmer



UN1338
Yarn cutting machine



UN1668
Yarn drawing machine



UN-GH2-8
Grass hat sewing machine



UN-GS72-3
1 needle 2 thread chain stitch glove sewing machine

UN-GS72-3
 UN-GS72-3K with edge cutter



UN-PK201
1 needle 2 thread chain stitch glove sewing machine





UN-338-RM

Fluting sewing machine
UN-338-R 12needles
UN-338-RM 16needles

UN668-04

4 needles pleating sewing machine
UN668-18 16 needles
UN668-20 20 needles



| | | |
|----|--|--|
| 01 | | |
| 02 | | |
| 03 | | |
| 04 | | |
| 05 | | |
| 06 | | |
| 07 | | |
| 08 | | |
| 09 | | |
| 10 | | |
| 11 | | |
| 12 | | |
| 13 | | |
| 14 | | |

UN1250G

Chainstitch gathering sewing machine

UN1260G

Multi-function chainstitch gathering machine

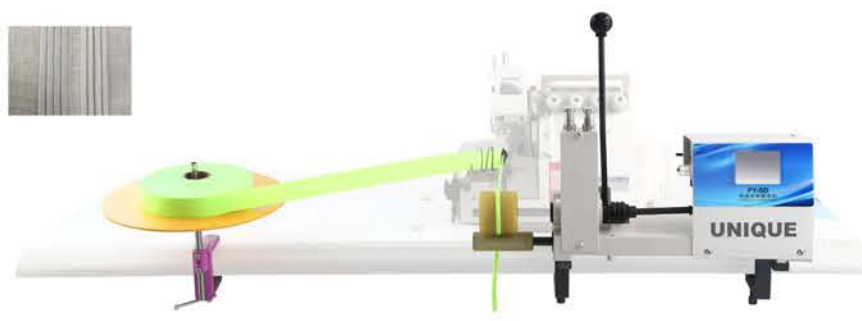

UN-3000-1400

Automatic pintuck sewing machine

UN-PY-SD

Front pull strip turning machine special for pasta type
Suitable for overlock / interlock / chainstitch sewing machine



UN-PY-SP

Front pull strip turning machine special for pasta type
Suitable for overlock / interlock / chainstitch sewing machine

UN-PK-SP

Front pull strip turning machine special for pasta type
Suitable for overlock sewing machine

UN-F2610S-DD

Fur sewing machine for binding the cord

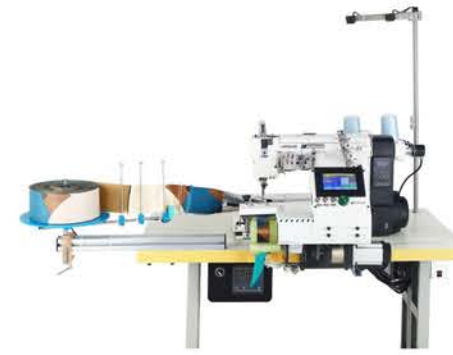

UN-TFSI20

Fully automatic tape-flipping sewing machine (with ironing function)

UN-TF21

Fully automatic tape-flipping sewing machine

UN-TN22

Fully automatic twin-needle sewing machine



UN-FLSC23

Fully automatic fur leather strip-cutting machine



UN-PI24

Fully automatic piping insertion machine (4-strip)



UN-BS32

Beads sewing machine



UN-BL32

Beads sewing machine

Computerized wheel-feed, needle feed post bed lockstitch sewing machine

Auto trimmer, auto foot lifting, auto reversing



UN591-ES

with step motor

UN591-ES 1 needle
UN592-ES 2 needles



UN592T-ES

with step motor

UN591T-ES 1 needle
UN592T-ES 2 needles



UN591S-ES (18CM)

Smaller and higher post with step motor

UN591S-ES (18cm 1 needle with 18cm height post
UN592S-ES (18cm 2-needle with 18cm height post
UN591S-ES (32cm 1 needle with 32cm height post



UN9910

Wheel-feed, needle feed post bed lockstitch sewing machine

UN9910 1 needle UN9910R 1 needle with back stitch
UN9920 2 needle UN9920R 2 needle with back stitch



UN9910DD

Direct drive wheel-feed, needle feed post bed lockstitch sewing machine

UN9910DD 1 needle
UN9920DD 2 needle



UN-S9910

Small post bed roller driver lockstitch sewing machine (For baby shoes)



UN810

Post bed sewing machine

UN810 1 needle
UN820 2 needle
UN815 With Presser foot (For Hat sewing)



1 needle



2 needle

Optional



Flip cover



Edge cutter device



UN-815DD-WS

Direct drive post bed sewing machine for wig



UN-5815-WS

Computerized post-bed sewing machine for wig

With auto thread trimmer



UN-5816

Computerized needle feed post-bed sewing machine with auto thread trimmer for cap visor



UN-5816QHD

Computerized needle feed post-bed sewing machine with cutter for cap sweatband

UN868-221226

Computerized compound feed post bed lockstitch sewing machine with auto trimmer, back-reverse stitch and pneumatic foot lifer

Auto trimmer, Auto foot lifting, auto stitch distance adjustable, auto reversing

UN868-121226 1 needle
UN868-221226 2 needle



UN1760



UN1760D-7

Compound feed post bed 1/2 needle lockstitch sewing machine

Auto foot lifting, auto reversing, large hook

UN1710D-7 1 needle, computerized with auto trimmer and foot lifer
UN1710D 1 needle, direct drive
UN1710 1 needle, basic

UN1760D-7 2 needles, computerized with auto trimmer and foot lifer
UN1760D 2 needles, direct drive
UN1760 2 needle, basic

UN1765D-7 2 needles with split needle bar, computerized with auto trimmer and foot lifer
UN1765D 2 needles with split needle bar, computerized
UN1765 2 needles with split needle bar, direct drive



UN1760D-L18-7

18 inch long arm work space

14 inch long arm also available

To change the model number from L18 to L14

UN1710D-L18-7 1 needle, computerized
UN1710D-L18 1 needle, direct drive
UN1710-L18 1 needle, basic
UN1760D-L18-7 2-needle, computerized
UN1760D-L18 2-needle, direct drive
UN1760-L18 2-needle, basic



GC20606P-2-L18-P

Compound feed high post bed 2 needle lockstitch sewing machine with 18 inch wide working space with pneumatic foot

GC20606P-1-L18-P 1 needle



GC20606P-2

Compound feed post bed 2 needle lockstitch sewing machine

GC20606P-1 1 needle



Height: 443mm

UN8365

Ultra high post bed compound feed lockstitch sewing machine

UN8365 Large Hook
UN8365S Small Hook

Other sizes of post height also available:

178mm 250mm 303mm 350mm and more can be customized



UN8365SW

Ultra high post bed compound feed lockstitch sewing machine (Swinging post-bed)



UN8365RB

Rotatable bent post bed sewing machine

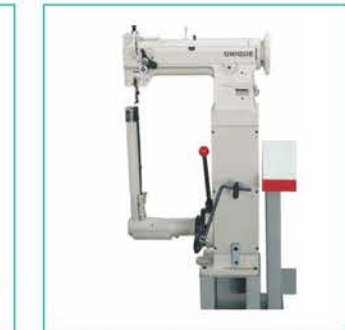

UN8365L

L shape lockstitch sewing machine



UN669-180312-7/P

Computerized compound feed cylinder bed lockstitch sewing machine with auto trimmer, back-reverse stitch and pneumatic foot lifer

UN669-180312-P

direct drive with auto back-reverse stitch and pneumatic foot lifer



UN669-111226

Computerized compound feed cylinder bed lockstitch sewing machine with auto trimmer, back-reverse stitch and pneumatic foot lifer

UN669-111226 1 needle, single differential feed
UN669-121226 1 needle, double differential feed



UN269-373

Compound feed cylinder bed 1-needle lockstitch sewing machine

UN269-273 2-needle



UN335P-7/P

Computerized compound feed cylinder bed lockstitch sewing machine with auto trimmer & foot lifer



UN335P-A

Compound feed cylinder bed lockstitch sewing machine

UN335P-B large hook



UN1341-7/P

Computerized compound feed cylinder bed lockstitch sewing machine with auto trimmer & foot lifer



UN1341

Cylinder bed compound feed lockstitch sewing machine (Large hook, oil lubrication)



UN341

Cylinder bed compound feed lockstitch sewing machine



UN1441-7/P

Computerized compound feed cylinder bed lockstitch sewing machine with auto trimmer & foot lifer



UN1441

Compound feed cylinder bed lockstitch sewing machine

UN1341M-B big hook



UN1442

Cylinder bed compound feed lockstitch sewing machine (2 needle)



UN343-1SB

Computerized cylinder-bed compound feed lockstitch sewing machine with large bobbin and auto lubrication with 1 step motor for auto trimmer



The large cylinder platform design makes the rotation more flexible and convenient when sewing larger items or tubular items.



Selected high-quality large rotary hook, smooth operation, not easy to jam or break the thread.



OPTIONAL

Hot cutter for binding tape with feeding roller



UN335A

Compound feed cylinder bed lockstitch sewing machine

UN335B Big hook



UN335BU-DD

Direct drive compound feed cylinder bed lockstitch sewing machine (auto oil)



UN8BU-DD

Direct drive cylinder bed compound feed lockstitch sewing machine



UN8BU

Cylinder bed compound feed lockstitch sewing machine

UN8B Small hook
UN8U Small hook, Oil lubrication
UN8B-LG Large hook



UN246D

Direct drive cylinder bed compound feed lockstitch sewing machine



UN246V

Cylinder bed compound feed lockstitch sewing machine (With binding)

UN246V With binding
UN246 Basic model
UN246U Oil lubrication



UN441

Cylinder bed compound feed lockstitch sewing machine (For extra heavy duty)



UN441-S

Cylinder bed compound feed lockstitch sewing machine (Short cylinder)



UN8BL

Long arm compound feed cylinder bed lockstitch sewing machine

Working space 610mm



UN1341L

Long arm compound feed lockstitch sewing machine

Working length: 600mm/800mm/1000mm



UN441L

Long arm compound feed lockstitch sewing machine

Cylinder bed compound feed lockstitch sewing machine(For extra heavy duty)

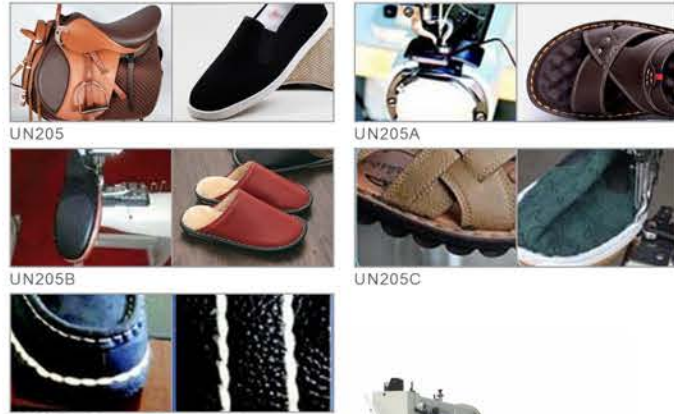

UN205D For extra big thread



UN205



UN-M82-12

2 needle moccasin sewing machine (With 12 patterns)

UN-M82D-360

Computerized 2 needle moccasin sewing machine (With 360 patterns)



UN-M204-D-1

Computerized 2 needle moccasin sewing machine(With 298 patterns) Large Shuttle hook for big thread



UN-M204P-D-200

Computerized post bed 2 needle moccasin sewing machine(With 200 patterns) Large Shuttle hook for big thread. For heavy duty material, Compound feed



UN-05F-D

Computerized 2 needle feed off the arm moccasin sewing machine (With 50 patterns)



UN-05F

2 needle feed of arm moccasin sewing machine(With 12 patterns)



UN8820-200

Computerized wheel feed presser foot post bed 2 needle moccasin sewing machine (With 200 patterns)



UN-S168-D

Computerized side sewing machine Swinging of arm control by computerized, more easy to operation



| | | | |
|---|----------|----|----------|
| 0 | | 10 | UNXXXXXX |
| 1 | UNXXXXXX | 11 | UNXXXXXX |
| 2 | UNXXXXXX | 12 | UNXXXXXX |
| 3 | UNXXXXXX | 13 | UNXXXXXX |
| 4 | UNXXXXXX | 14 | UNXXXXXX |
| 5 | UNXXXXXX | 15 | UNXXXXXX |
| 6 | UNXXXXXX | 16 | UNXXXXXX |
| 7 | UNXXXXXX | 17 | UNXXXXXX |
| 8 | UNXXXXXX | 18 | UNXXXXXX |
| 9 | UNXXXXXX | 19 | UNXXXXXX |

双针 不适用

双针交叉叉

UN-S268-D-35

Computerized side pattern sewing machine



UN-S168-B

1 needle 2 thread side sewing machine



UN-S168

1 needle 2 thread side sewing machine



UN-S168-DD Direct drive



UN-S168-1

1 needle 2 thread side sewing machine



UN-S161

1 needle 1 thread side sewing machine



UN-S168-FB

1 needle 2 thread side sewing machine (For bag)



UN-S268-FB

1 needle 2 thread side sewing machine (For draw-bar frame)





UN-700A-3S
Fully automatic auto lubrication disc feed overseaming machine

Auto trimmer
auto foot lifting
low noise & power saving
sewing path memory system
Reduce the skill level required for sewing needle position



UN-610-S-PUT-P



UN-610-S

Auto lubrication disc feed overseaming machine (stitch control by step motor) needle position

Needle position
Low noise & power saving



UN-600A-PUT-P

UN-600A-PUT-P Auto trimmer, auto foot lifting
UN-600A-DD Direct drive
UN-600A Basic type
UN-600A-DD-SP Direct drive, auto foot lifting by step motor



UN-600B-DD

UN-600B-DD Direct drive
UN-600B Basic type
UN-600B-DD-SP Direct drive, auto foot lifting by step motor



UN-800-1
Single thread overseaming machine for insoling (Auto lubrication)



UN-800-2
1 needle 2 thread fur and other fabric sewing machine (Auto lubrication)



UN-F2610-T-P
Fur sewing machine series (direct drive)

UN-F2610D-T-P For toy sealing, auto foot lifting



UN-F2610-4DD
Fur sewing machine (Light material)



UN-F2610-5AD
Fur sewing machine (Middle and heavy material)



UN-F2610-5DD
Fur sewing machine (Light and middle material)



UN-F2610-5BD
Fur sewing machine (Light and heavy material)



UN-F2610-5KD
Fur sewing machine (Light material)



UN-F2610-5FD
Fur sewing machine (Middle and heavy material)



UN-F2610-6AD
Fur sewing machine (Middle and heavy material)



UN-F2610-CD
Fur sewing machine (Light and middle material)



GP-402
Direct drive 1-thread overseaming machine

Small pressing wheel with sewing thickness: 5.5mm
UN-402-DD small pressing wheel, direct drive
UN-402A big pressing wheel, basic model
UN-402A-DD big pressing wheel, direct drive
UN-402 Small pressing wheel



UN-402A Big pressing wheel



GP-202A-DD
Direct drive 1-thread overseaming machine
Small pressing wheel with sewing thickness: 3.5mm
GP-202-DD big pressing wheel, direct drive



GP-302DD
Direct drive 1-thread overseaming machine
Big pressing wheel with sewing thickness: 4.5mm
GP-302 big pressing wheel, basic model



UN-F4-4 (GP5-1)
Fur sewing machine
For light duty



UN-F4-5 (GP5-2)
Fur sewing machine
For light to medium heavy duty

UN-F4-5A (GP5-3)
For medium to heavy duty



UN-F4-6A (GP5-5)
Single thread overseaming machine for insoling



Inner fabric trimming machine



UN-FT902D
UN-FT902D Motor in the machine
UN-FT902DB Motor in the machine,
Thin knife



UN-FT902
Basic model



UN-FT903
Control by foot panel



UN-FT203
UN-FT203 For lady shoes
(also working when the up
of shoes is finished.)
UN-FT203Z Motor in the machine



UN-FT207
For small hole



UN-FT202LM
UN-FT202L For rain shoes



UN-FT202Q



UN-FT206
UN-FT206D For climbing boots



UN-FT311
For hole trimmer



UN-FT907
For heavy duty rubber boots



UN-FT300
For bag



UN-FT111
For bag



UN-FT906
For heavy material



UN-FT336B
Flattening machine



UN-FT669
Seam opening and tape attaching
machine



UN-225
Seam opening and tape attaching
machine



UN-S747
Shoe stitch machine for moccasins

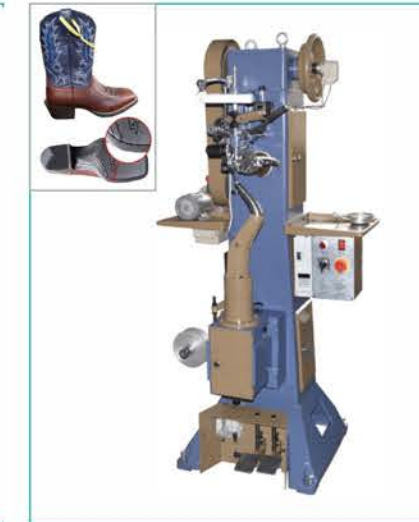

UN-S998
Stand type inser sewing machine



UN-S368/2
Out seam sewing machine for shoes



UN-S350A
Outside seam pattern sewing machine



UN-S654
3 needle chainstitch sewing machine
UN-S654 for shoes upper
UN-S654T for cricket ball



UN-S619
Double needle welt sewing machine



UN2972
Shoes repairing machine
UN2972B Large hook
UN2973 Long arm



UN2927
Shoes repairing machine



UN2926
Shoes repairing machine

L type cylinder



UN-CM292
Computerized hot-cement edge folding machine



UN-CM298-B
Computerized hot-cement edge folding machine



UN-CM998
Computerized hot-cement edge folding machine



UN-CM929
Computerized hot-cement edge folding machine (For wallet)



UN-CM928
Computerized hot-cement machine (For zipper)
UN-CM928 Basic type
UN-CM928-A Automatic zipper cutting
UN-CM928-F Working with zipper head



UN-CM296
Auto-cementing and pounding machine



UN-SG240
Strong force fluing machine
UN-SG40 40mm, 150W UN-SG240-1 240mm, 550W
UN-SG120 120mm, 150W UN-SG400 400mm, 550W
UN-SG180 180mm, 150W UN-SG600 600mm, 550W
UN-SG240 240mm, 370W



UN-WG101
White gluing machine
UN-WG101 width: 270mm rubber roller



UN-WG107
White gluing machine (2 gluing areas)
UN-WG107 width: right 100mm, left 270mm iron roller



UN-G250
Yellow glue machine
Glue width: 0-230mm



UN-G250-4
Yellow glue machine
Glue width: 0-300mm



UN-GC150
Glue coating machine
Glue width: 150mm, 45/120/210mm also available



UN-HMG831
Hot melt glue machine



UN-HMG841
Hot melt glue machine



UN-HMG851
Hot melt glue machine



UN-GS1946
Small glue spraying machine



UN-GS1950
Glue spraying machine



UN-GS1943B
Glue spraying machine



UN-SA2
Double head cover type shoes attaching machine



UN-ASA
Single head cover type automatic shoes attaching machine



UN-ASA2
Automatic double head cover type automatic shoes attaching machine



UN-189-B
Automatic four claws nail attaching machine
(for square & round shape)



UN-198
Automatic four claws nail base button plastic pearl attaching machine



UN-198-8B
Automatic hollow nail (with rhinestone) up-down rivet attaching machine



UN-198-9
Automatic four claws base button plastic pearl nail attaching machine



UN-198-9X
Automatic plastic button attaching machine (different shapes)



UN-198-E
Automatic pineapple nails plastic button attaching machine (both round shape and other shapes for heavy duty)



UN-HF-S2
Double disc rhinestone hot fix machine
UN-HF-S1 one disc
UN-HF-S2 two disc



UN-RB01
Rhinestone brushing machine



UN-HF-S2-H6
Computerized multi head rhinestone hotfix machine
UN-HF-S2-H6 6 head



UN-EH-98A
Automatic double side eyelet punching machine



UN-EH-98
Automatic double side eyelet punching machine



UN-EH-98E
Automatic electric double side eyelet punching machine



UN-EH-95
Automatic electric double side eyelet punching machine



UN-PH228-A
CNC leather punching hole machine



UN-PH30
Automatic leather punching hole machine



UN-HB917
Automatic hook button attaching machine



UN-CS908
Climbing shoes button attaching machine



UN-CS918
Climbing shoes button attaching machine (Automatic bottom eyelet button feed)

Extra heavy duty sewing machine



GR1-2

Max thickness: 18mm
Working area: 190*170mm
Stitch length: 5-9mm
Speed: 300-600 rpm
For shoes



GR1-8-1

Max thickness: 40mm
Working area: 190*240mm
Stitch length: 8-12mm
Speed: 400 rpm
Presser foot height: 15/40mm



GA3-1

Max thickness: 5mm
Stitch length: 3.6mm
Speed: 1400 rpm
Presser foot height: 8mm



GA5-1

Max thickness: 85mm
Working area: 268*166mm
Stitch length: 7mm
Speed: 800 rpm
Presser foot height: 12mm



GA5-5

Max thickness: 85mm
Working area: 268*166mm
Stitch length: 7mm
Speed: 800 rpm
Presser foot height: 12mm



GB4-4

Stitch length: 12mm
Speed: 700 rpm
Presser foot height: 30mm
Up and down feed



UN2820

Stitch length: 12mm
Speed: 1200 rpm
Presser foot height: 13/20mm
Compound feed
Double needle



UN255

Stitch length: 14mm
Speed: 1200 rpm
Extra large hook
Up and down feed



GB6-181

Working area: 200*420mm
Stitch length: 12mm
Speed: 800 rpm
Presser foot height: 13/22mm
Up and down feed



GA243

Stitch length: 15mm
Speed: 800 rpm
Presser foot height: 13/20mm
Compound feed



GA-P243

Compound feed



GN2502K-DD

Direct drive carpet overlock sewing machine



GN2502: 2 thread
GN2502K: 2 thread with knife
GN2503: 3 thread
GN2503K: 3 thread with knife
GN2501: 1 thread
GN250N: For net sewing



UN2502D-W

Movable carpet overlock machine



GN2502K

Carpet overlock sewing machine



GN2200

Carpet fringing & overedging machine



GN20-2A

Carpet overlock sewing machine



GN20-2A: 2 thread For carpet
GN20-3A: 3 thread For carpet
GN20-1: 1 thread For fabric joining
GN20-2: 2 thread For bag(10-16mm width)
GN25-6: 3 thread For net sewing



GN309

Carpet overlock sewing machine

GN309 3 thread with knife
GN308 3 thread
GN304 2 thread with knife
GN303 1 thread joining



GK81300

Up and down feed 2 needle chainstitch and overlock sewing machine

Thickness: 22mm
Needle distance: 5mm
Max stitch width: 20mm



GK80700

2 needle 4 thread chainstitch sewing machine

Thickness: 18mm
Needle distance: 7.2mm



GK8-2

Bag sewing machine

GK8-2 1 needle
GK8-24 2 needle



Automatic folding and bag closing sewing machine (Bag closing + Stand + Folding device + Feeding device)
Feeding length: 1.5m, 2m, 2.5m, 3m, 4m



Automatic bag folding machine



ZB4907
Fit for GK35-6A/DS-9C



ZB4900
Fit for GK35-6A/DS-9C



ZB4900-3
For full automatic automatic counting, filling and feeding line



S stand+Folding+Machine
ST-S + ZB4907 + DS-9C

DS-9C/GK95-1
High speed 1 needle 2 thread bag closing machine
Speed: 2700 rpm
Stitch length: 7-10.5mm



R stand+Folding+Machine
ST-S + paper folding device + GK35-6A

GK35-6A/7
High speed 1 needle 2 thread bag closing machine
GK35-6A: basic type
GK35-6AF: left side of GK35-6A
Speed: 2000 rpm
Stitch length: 6.5-11mm
Max thickness: 8mm



DS-7C
Bag closing machine
Continuous operation (For automatic packing line)



GK35-2C/80800
1 needle 2 thread bag closing machine
Speed: 1900 rpm
Stitch length: 6.5-11mm
Max thickness: 8mm



GK35-2CF/80800F
1 needle 2 thread bag closing machine (left side of GK35-2C)
Speed: 1900 rpm
Stitch length: 6.5-11mm
Max thickness: 8mm



Feeding device for GK series



GK9-350
Portable bag closer machine
GK9-350 1 needle 1 thread
GK9-390 Auto oil lubrication
GK9-400 1 needle 1 thread for fabric
GK9-550 1 needle 2 thread



GK9-2
Portable bag closer machine
GK9-2 1 needle 1 thread
GK9-8 Upgrade type
GK9-25 1 needle 2 thread
GK9-18A For bags with film covered surface



GK9-900
Portable bag closer machine
With separate battery
5200 mAh



GK9-900A
Portable bag closer machine
With battery built-in
2600 mAh



GK35-2S
1 needle 2 thread up and down feed bag sewing machine
Stitch length: 9-15mm
Max thickness: 18mm



GK35-8A
2 needle 4 thread bag closing machine (Pneumatic thread cutter)
Speed: 1900 rpm
Stitch length: 8-12mm
Max thickness: 8mm



GK26-1A
Portable bag closer machine
GK26-1A 1 needle 1 thread
GK26-2A 1 needle 2 thread
GK26-22 2 needle 2 thread
GK26-1S 1 needle with feeding



GK9-770
Portable bag closer machine
With 2 needle 4 thread



GK35-1
1 needle 2 thread bag sewing machine
Stitch length: 9-15mm
Max thickness: 15mm



GK35-6
1 needle 2 thread bag closing machine with auto thread cutter
Speed: 1900 rpm
Stitch length: 6.5-11mm
Max thickness: 8mm

Ultrasonic seaming machine

UN-U60 - 1S - Q

60: 60mm
100: 100mm
200: 200mm

2S: 2 motor
1S: 1 motor

Q: Auto foot lifting

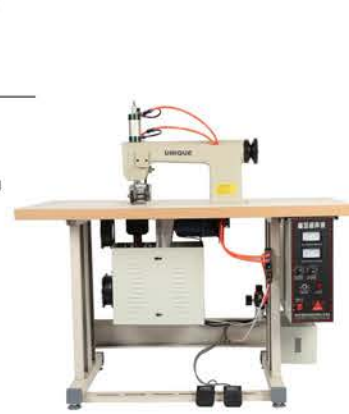

UN-U60-2S-Q



UN-U60-1S-Q



UN-SK
Feed off the arm ultrasonic seaming machine (For sleeve seaming without thread stitch)
Working Width: 1.5-25mm
Production speed: 1-20m/min



UN-SK-W
Feed off the arm ultrasonic seaming machine (For sleeve seaming without thread stitch)
Working Width: 1.5-25mm
Production speed: 1-20m/min



UN-U50-Q-1
Nonwoven bag handle welding machine
UN-U50-Q-1 Single head
Working area: 40*40mm
UN-U50-Q-2 Double head
Max working width: 20mm
Max distance between two heads: 160mm



UN-UW05A
Ultrasonic seaming machine
Rubber roller width: 35mm



UN-DK
High-frequency plastic welding machine
UN-TF-4000 Power: 4000W
UN-TF-5000 Power: 5000W
UN-TF-8000 Power: 8000W



UN-DK
D-cut machine
Working area: 20*80mm



UN-F1151
Automatic washing label stacking machine with ultrasonic cutter
Patented pick-up device, 1-5 pieces at a time
360° rotary feeding with adjustable stacking position
Vision positioning + ultrasonic cutting, neat edges
Circulating collecting system, auto sorting good/bad labels
Real-time refilling module, 5 trays, 200 pcs each



UN-U700-B
Nonwoven bag making machine
Working area:
Length: 200-600mm Width: 100-800mm



UN-SL-W02B
Seamless bonding machine
Max temperature: 300°C
Rubber roller width: 0-15mm



UN-SL-B018E
Seamless bonding machine
Max temperature: 400°C
Rubber roller width: 0-15mm



UN-SL-W02E
Seamless bonding machine
Max temperature: 400°C
Rubber roller width: 0-15mm



UN-SL-W02A
Seamless bonding machine
Max temperature: 300°C
Rubber roller width: 0-15mm



UN-USL-W06B
Ultrasonic seamless bonding machine
Max temperature: 300°C
Rubber roller width: 0-15mm



UN-SL-W03B
Flat bed seamless joining machine
Max temperature: 300°C
Rubber roller width: 35mm



UN-SL-W03C
Flat bed seamless joining machine
Max temperature: 300°C
Rubber roller width: 35mm



UN-SL-W02F
Seamless joining machine
Max temperature: 300°C
Rubber roller width: 0-15mm



UN968-12
Adhesive film fusing machine



UN-SLG11-CK-E
Seamless button holing machine
UN-SLG11-CK-E Electronic type
UN-SLG11-CK-P Pneumatic type



UN-SLG11-MJ-E
Seamless placket opening machine
UN-SLG11-MJ-E Electronic type
UN-SLG11-MJ-P Pneumatic type



UN-G10-XB
Ultrasonic edge trimming and splicing machine





UN-HS-B01L
Hot air seam sealing machine
Max temperature:650°C



UN-HS-B015L
Hot air seam sealing machine
Max temperature:650°C



UN-HS-B07L
Hot air seam sealing machine
Max temperature:650°C



UN-HS-B08L
Hot air seam sealing machine
Max temperature:650°C



UN-HS-B02L
Hot air seam sealing machine
Max temperature:500°C



UN-HS-B02V
Hot air seam sealing machine
Max temperature:500°C
Bendable



UN-HS-B05L
Hot air seam sealing machine
Max temperature:650°C



UN-HS-BL12-PE
Hot air seam sealing machine
Max temperature:650°C



UN-HS-B17F
Hot air seam sealing machine
Max temperature:650°C



UN-HS-B016L
Hot air seam sealing machine
Max temperature:650°C



UN-HS-W02C
Hot air seam sealing machine
Max temperature:500°C



UN-HS-W02D
Hot air seam sealing machine
Max temperature:300°C



UN-101
Ultrasonic feeder



UN-102
Trousers press



UN-105
Small positioning machine



UN-106A
Three station cold and hot press
pant head machine



UN-107
Rear middle glue feeder



UN-108
Composite machine



UN-109
Pneumatic tension machine



UN-SYJ-A
Underwear brush adhesive bonding machine



UN-YN-D
Seamless underwear pressing machine



UN-DT10065-ZL
Visual PUR Glue Dispensing Machine



UN-3560FP
Hot and cold dual-mode flat press machine



UN-200VP
Hot and cold dual-mode visor press machine





GN-AO-U4

Microcomputer automatic fitted sheet machine

GN-AO-U4 4 thread
GN-AO-U5 5 thread



UN-FB5B

Fully automatic mattress tape edge machine with flipping device

Mattress thickness: 50-450mm
Platform lift range: 0-350mm
Platform size: 4200*2150mm



UN-FB6

Semi-auto mattress tape edge machine

Mattress thickness: 10-520mm
Platform lift range: 0-260mm
Platform size: 1960*1560mm



UN-FB2

Mattress tape edge machine

Mattress thickness: 10-450mm
Platform lift range: 0-260mm
Platform size: 1960*1560mm



UN-FB1

Manual mattress tape edge machine

Mattress thickness: 30-550mm
Platform lift range: 0-260mm
Platform size: 1960*1560mm



UN-KB-5

Heavy duty mattress overlock sewing machine

maximum sewing thickness 80mm



UN-Q64-3-5

High-speed computerized lock stitch multi-needle quilting machine

UN-Q64-3-5 Quilting width 1650mm 2 needle row with 3*2" inch between needle bars
UN-Q64-3-6 Quilting width 1650mm 2 needle row with 3*3" inch between needle bars



UN-QE34F

High-speed computerized multi-needle quilting and embroidery machine

Quilting width 1700mm+1700mm with 17+17 heads



UN-HX200

Fully automatic horizontal quilting machine



UN-Q3200B

High-speed computerized chain stitch multi-needle quilting machine

Quilting width 2450mm
3 needle rows with 3*3" inch between needle bars



UN-F216D

Computerized fabric pleating machine

Working width 0-1600mm/3000mm
Pleating height 2-25mm
Pleating width ≥2mm



UN-Q26E

Computerized single needle quilting machine

| Model | UN-Q26E | UN-Q28E | UN-Q30E |
|-------------|---------------------------------|-----------|-----------|
| Quilt size | 2.6mx2.8m | 2.8mx3.2m | 3.0mx3.2m |
| Sewing size | 2.4mx2.6m | 2.6mx3.0m | 2.8mx3.0m |
| Head | 1 needle lockstitch, large hook | | |

EMBROIDERY & HOUSEHOLD SEWING MACHINE

EMBROIDERY & HOUSEHOLD SEWING MAC

TOPDIS



UN-C1201

Single head with 12 needles, 400*500mm
UN-C1201-4060 (400*600mm)

UN-C1501

Single head with 15 needles, 400*500mm
UN-C1501-4060 (400*600mm)



UN-C1201-5080

Single head with 12 needles, 500*800mm
UN-C1201-50100 (500*1000mm)
UN-C1201-50120 (500*1200mm)



with cap frame and flat frame

with cap frame and flat frame

with only flat frame



UN-C1202

Two head with 12 needles, 400*500mm

UN-C1502

Two head with 15 needles, 400*500mm



UN-C1203

Three head with 12 needles, 400*450mm

UN-C1503

Three head with 15 needles, 400*450mm



UN-C1204

Four head with 12 needles, 400*450mm

UN-C1504

Four head with 15 needles, 400*450mm



UN-F1201+CH
Special embroidery machine for flat, chenille and chain stitch



UN-F1201+PD
Special embroidery machine for flat, coiling and taping

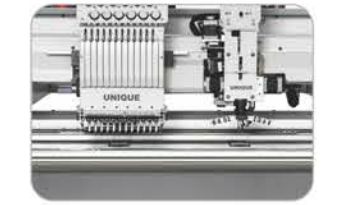

UN-C1206

Computerized multi head cap embroidery machine



UN-C1208

Computerized multi head cap embroidery machine

| 型号(Model) | 刺绣面积(Emb.Space) | 速度(Speed) | 针数(Needle) | 头数(Head) | 毛重(G.W) | 包装尺寸(MEAS) |
|-------------|-----------------|-----------|----------------------|----------|---------|------------------------|
| UN-C1206 | 400X450mm | 1200rpm | 12(9 and 15 adopted) | 6 | 1200kgs | 350X112X160cm |
| UN-C1208 | 400X450mm | 1200rpm | 12(9 and 15 adopted) | 8 | 1500kgs | 422X112X160cm |
| UN-C1210 | 400X450mm | 1200rpm | 12(9 and 15 adopted) | 10 | 1800kgs | 530X155X160cm |
| UN-C1212 | 400X450mm | 1200rpm | 12(9 and 15 adopted) | 12 | 2200kgs | 580X112X160cm |
| UN-F1201+CH | 500X1200mm | 1000rpm | 9(12 adopted) | 1+1 | 400kgs | 140X105X95/257X27X16cm |
| UN-F1201+PD | 500X1200mm | 1000rpm | 9(12 adopted) | 1+1 | 400kgs | 140X105X95/257X27X16cm |

UN-F Series

Flat embroidery machine



| | | |
|----------------------------|--------------------------------------|--|
| Stitching length | 0.1-12.7mm | |
| Speed | 1200rpm | |
| Motor | Dahao Servo motor or X15 Servo motor | |
| Guide rail | High-speed bead holder guide rails | |
| Pattern format | DST/DSB/DHA | |
| Optional Additional device | Network Management Function | Independent Carving/boring Knife |
| | Bluetooth Remote Control | Independent Pressure Foot |
| | Easy Cording Device | Laser cutting device |
| | Sequin Device | Auto BobbinChange |
| | Simple Towel Device | Bead Device/single Color/double Color/triple color |



High-speed embroidery machine is widely used in high-end brand embroidery of fashion, children's wear, wedding dress, home textiles, knitting, shuttle weaving, cotton and hemp, leather, polyester, fiber and other fabrics, with outstanding performance.

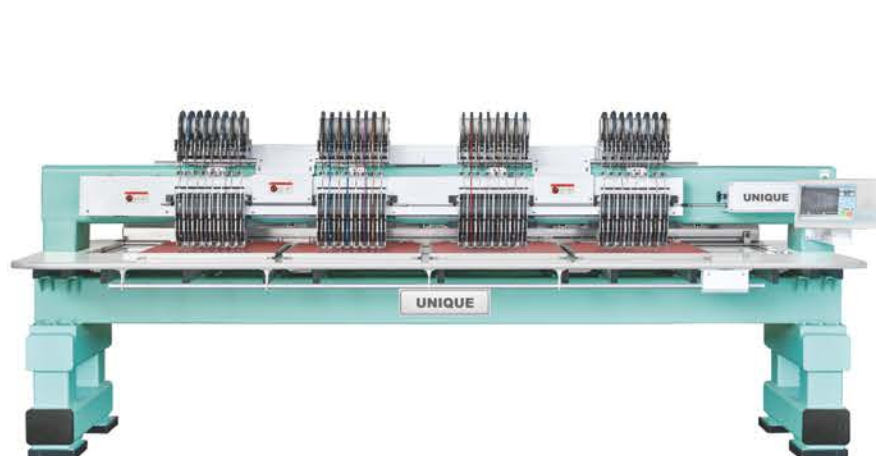

UNP804

Automatic sequin punch press machine

| 头数 Head No. | 色数 Color No. | 机头距离(mm) Head Distance | 框架范围(mm) Frame Area | 贴片行程(mm) Material Ranges | 机器尺寸(mm) Machine size |
|----------------|-----------------|---------------------------|------------------------|-----------------------------|--------------------------|
| 1 | 12 | 0 | 510*450 | 460*410 | 1210*1020 |
| 4 | 8 | 600 | 530*590 | 490*550 | 3450*1417 |
| 10 | 8 | 550 | 600*750 | 600*650 | 7950*2057 |
| 12 | 8 | 600 | 650*750 | 650*650 | 10220*2057 |

Widely used in clothing, footwear, bags, bedding and handicrafts industries. While combined with processes of embroidery, laser and sequin punch press, it enriches personalized design.

8 in 1 magnetic frame



Pocket frame



Robot frame



Easy robot frame



Pneumatic robot frame

Single sequin device



Double sequins device



Multi sequins device



Easy cording device



Rhinestone device



Sock device



Beads device



Loose beads

Beads device



Rolling beads

Easy laser cutting device



Red laser position device



Laser cutting device





UN-MC1201
Computerized embroidery machine

Working area:200*300mm
Flat & Cap embroidery
UN-MC1201 12 needles
UN-MC1501 15 needles

UN-KC1501
Computerized embroidery machine

Working area:360*240mm
Flat & Cap embroidery
UN-KC1201 12 needles
UN-KC1501 15 needles



ES-7
Household embroidery machine

Embroidery area: 200*380mm
312 built-in embroidery patterns



ES-6
Household embroidery machine

Embroidery area : 200*280mm
312 built-in embroidery patterns



ES-5
Household embroidery & sewing machine

Embroidery area:100*235mm
96 built-in embroidery patterns
ES-5B Embroidery only



ES-3
Household embroidery machine

Embroidery area:100*235mm
96 built-in embroidery patterns
ES-3B Embroidery only



UN-710
Multi-function household sewing machine 180 patterns



UN-600
Multi-function household sewing machine 146 patterns



UN-460
Multi-function household sewing machine 146 patterns



UN-410
Multi-function household sewing machine 80 patterns



UN-E380
Multi-function household sewing machine 23 patterns



UN-E360
Multi-function household sewing machine 23 patterns



UN-E340
Multi-function household sewing machine 24 patterns



UN-E310
Multi-function household sewing machine 24 patterns



JH820ATF
Multi-function household sewing machine 15 stitch patterns 4 button hole patterns



JH653
Multi-function household sewing machine 19 stitch patterns 4 button hole patterns



JH920
Multi-function household sewing machine 15 stitch patterns 4 button hole patterns



FN2-4D
Household overlock sewing machine
FN2-4D 4 thread
FN2-4D-B 4 thread with light



FN2-7D
Household overlock sewing machine
FN2-7D 3 thread
FN2-7D-B 3 thread with light



GN434D
Household overlock sewing machine



GN703
Household overlock sewing machine
2/3/4 thread / narrow overlock with LED light



GN320
Household overlock sewing machine
2/3/4 thread with thread cutter



GN328
Household overlock sewing machine
2/3/4 thread with thread cutter



GN1-1D
Household overlock sewing machine
GN1-1 1 needle 3 thread
GN1-1D 1 needle 3 thread with motor



GN1-6D
Household overlock sewing machine
GN1-6 1 needle 3 thread
GN1-6D 1 needle 3 thread with motor



JA2-1
Household sewing machine
JA2-1 JA2-2



ESP-810E
Steam press
ESP-810E 26"
ESP-810EL 32"
ESP-810EXL 36"
ESP-810EXXL 40"



SS-618
Electric steamer
Power:1950W
Water tank capacity:1.6L



SS-628
Electric steamer
Power:1950W
Water tank capacity:2.0L



UN3800DD-1N-SW
Sweater seaming machine



UN-SW788
Sweater seaming machine



UN-SW8G
Sweater seaming machine



UN-SK-6FPT
Computerized socks machine



UN-SK-7F
Auto-linking socks machine



UN-SK-WY08
Straight socks head toe closing machine



UN-KN1-52
Computerized knitting machine
1-system
Gauge: 7G, 7GV, 8G, 9G, 12G, 14G, 16G
Size: 52inch, 60inch, 66inch, 72inch, 80inch, 100inch



UN-KN2-52
Computerized knitting machine
2-system
Gauge: 5G, 7G, 7GV, 8G, 9G, 12G, 14G, 16G
Size: 52inch, 60inch, 66inch, 72inch, 80inch, 100inch



UN-SW3-80
Computerized knitting machine
3-system, for sports shoe upper
Gauge: 5G, 7G, 7GV, 8G, 9G, 12G, 14G, 16G
Size: 52inch, 60inch, 66inch, 72inch, 80inch, 100inch



UN-1200LLP

Pneumatic straight linear fusing machine with 1.5m long heating area

| | | |
|------------|--------|--------|
| UN-600LLP | 600mm | 12.6KW |
| UN-900LLP | 900mm | 18KW |
| UN-1200LLP | 1200mm | 25.2KW |
| UN-1600LLP | 1600mm | 32KW |
| UN-1800LLP | 1800mm | 36KW |
| UN-2000LLP | 2000mm | 45KW |

Standard
1 couple of pressing rollers
UN-1200LLP

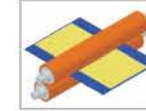

Option 1
2 couples of pressing rollers for better fusing result especially for super light materials
UN-1200LLP-2

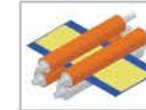

Option 2
Longer lower belt for easy input 60cm and 100cm length available
UN-1200LLP-S
UN-1200LLP-2-S



UN-900LFS

Pneumatic straight linear fusing machine with 1m long heating area

| | | |
|-----------|-------|-------|
| UN-600LFS | 600mm | 8.4KW |
| UN-900LFS | 900mm | 12KW |



NHG900-Q2-S

Pneumatic straight linear fusing machine

1.6m long heating area with 2 couples of rollers pressing and longer lower belt for input

| | | | |
|--------------|--------|--------|--------|
| NHG900-Q2-S | 900mm | 18.6KW | 18.6KW |
| NHG1000-Q2-S | 1000mm | 21KW | 21KW |
| NHG1200-Q2-S | 1200mm | 25.2KW | 25.2KW |



UN-450MS

Compact fusing machine with auto belt warping prevention

| | |
|----------|-------|
| UN-450MS | 450mm |
| UN-500MS | 500mm |
| UN-600MS | 600mm |
| UN-800MS | 800mm |



UN-600CX

Economical fusing machine with auto pneumatic belt warping prevention

| | | | |
|----------|-------|----------|-------|
| UN-200CX | 200mm | UN-600CX | 600mm |
| UN-450CX | 450mm | UN-800CX | 800mm |
| UN-500CX | 500mm | UN-900CX | 900mm |



UN-F500

Compact fusing machine

| | | | |
|---------|-------|---------|-------|
| UN-F300 | 300mm | UN-F700 | 700mm |
| UN-F400 | 400mm | UN-F800 | 800mm |
| UN-F500 | 500mm | UN-F900 | 900mm |
| UN-F600 | 600mm | | |

AUTOMATIC

UN-HE4060

Double-station pneumatic heat transfer machine with automatic up/down and left/right movement

- UN-HD1010 10*10cm
- UN-HD1515 15*15cm
- UN-HD2020 20*20cm
- UN-HD2525 25*25cm
- UN-HE3838 38*38cm
- UN-HE4060 40*60cm
- UN-HE5080 50*80cm
- UN-HE6080 60*80cm



UN-T4050

Double-station pneumatic heat transfer machine with automatic up/down and left/right movement

- UN-T4050 40*50cm
- UN-T5050 50*50cm
- UN-T5060 50*60cm



UN-1215B-D2

Double head heat press machine

SEMI AUTOMATIC



UN-HA3838

Double-station pneumatic heat transfer machine

- UN-HB1010 10*10cm
- UN-HB1515 15*15cm
- UN-HB2020 20*20cm
- UN-HB3030 30*30cm
- UN-HA3838 38*38cm
- UN-HA4060 40*60cm
- UN-HA5080 50*80cm
- UN-HA6080 60*80cm



UN-Q4060

Double-station pneumatic heat transfer machine

- UN-Q3838 38*38cm
- UN-Q4060 40*60cm
- UN-Q5060 50*60cm
- UN-Q5080 50*80cm
- UN-Q6080 60*80cm



UN-H2020

Pneumatic heat transfer machine

- UN-H1010 10*10cm
- UN-H1515 15*15cm
- UN-H2020 20*20cm
- UN-H3030 30*30cm
- UN-H4536 45*36cm



UN-SLC-18

Pneumatic curve heat press machine



UN-Z1010

Pneumatic trademark printing machine with automatic label winding, infrared stamping positioning. Working area 10*10cm.



UN-AM1010

Pneumatic heating transfer machine with automatic label suction and feeding device

- UN-AM1010 10*10cm
- UN-AM1020 10*20cm
- UN-AM2025 20*25cm



UN-GM4050

Double-station pneumatic heat transfer machine

- UN-GM3838 38*38cm
- UN-GM4050 40*50cm
- UN-GM1520 15*20cm



UN-GM1520



UN-38A

Heat transfer machine

- UN-38A 40*40cm
- UN-62A 40*60cm



UN-82

Heat transfer machine

- UN-38 40*40cm
- UN-62 40*60cm
- UN-82 40*80cm



UN-6080L

Heat transfer machine -large size

- UN-6080L 60*80cm
- UN-7090L 70*90cm
- UN-40100L 40*100cm
- UN-60100L 60*100cm
- UN-60130L 60*130cm
- UN-80100L 80*100cm



UN-EP3838

Heat transfer machine with electric pressing

- UN-EP3838 38*38cm
- UN-EP4060 40*60cm



UN-2020-YD2

Double-station pneumatic heat transfer machine

- UN-1515-YD2 15*15cm
- UN-2020-YD2 20*20cm
- UN-2525-YD2 25*25cm
- UN-2330-YD2 23*30cm
- UN-1535-YD2 15*35cm
- UN-4040-YD2 40*40cm
- UN-4050-YD2 40*50cm
- UN-4060-YD2 40*60cm



UN-4040-TD2L

Double-station upper sliding pneumatic heat transfer machine with infrared positioning with teflon heating plate (4 infrared sensors)

- UN-4030-TD2L 40*30cm
- UN-4040-TD2L 40*40cm
- UN-5040-TD2L 50*40cm
- UN-6040-TD2L 60*40cm
- UN-7050-TD2L 70*50cm
- UN-4060-TD2L 40*60cm



UN-V3838

Heat press machine with drawer-type lower plate with semi-auto opening by magnet-vertical type

- UN-V3838 38*38cm
- UN-V4050 40*50cm
- UN-V4060 40*60cm



UN-3838ZH-8

8 in 1 heat transfer machine

Heat transfer machine with 8 functions for flat/cup/cap etc.

- UN-2938ZH-8 29*38cm
- UN-3838ZH-8 38*38cm



UN-158A

Manual cap heat press machine with flat plate replaceable

8*15cm



UN-10120-D2

Pneumatic double-station gantry-type heat sublimation machine
 UN-80100-D2 80*100cm
 UN-10120-D2 100*120cm
 UN-120150-D2 120*150cm



UN-4060-D4-Y

Full automatic four-station heat transfer machine with teflon heating plate
 UN-4040-D4-Y 40*40cm
 UN-4050-D4-Y 40*50cm
 UN-4060-D4-Y 40*60cm



UN-RHT42190

Roller heat transfer machine
 UN-RHT20170 20*170cm
 UN-RHT42170 42*170cm
 UN-RHT42190 42*190cm



UN-60190

Roller heat transfer machine
 UN-60170 60*170cm
 UN-60190 60*190cm
 UN-80190 80*190cm



UN-IPF1011

Automatic heat transfer machine for attaching labels
 UN-IPF1011 4 stations
 UN-IPF1015 5 stations



UN-IP125-90

Pneumatic single-head monochrome pad printing machine



UN-S90-2

Trade mark printing machine
 2 colors
 UN-S90-1 1 color



UN-IP105M

Pneumatic ink pad printing machine



UN-AN004

Automatic numbering machine



UN-60-2PC-BH2

Digital white ink direct-to-film printer
 Maximum printing width: 60 cm, equipped with Epson I3200-A1 printheads, complete with powder shaker set
 UN-60-2PC-BH2 with 2 printheads
 UN-60-4PC-BH4 with 4 printheads



UN-30-2PC-A3

Digital white ink direct-to-film printer
 Maximum printing width: 30 cm, equipped with 2 Epson F1080 printheads, complete with powder shaker set
 Digital white heat transfer printer machine



UN-30-1PC-1080

Digital white ink direct-to-film printer
 Maximum printing width: 30 cm, equipped with 1 Epson F1080 printheads, complete with powder shaker set



UN-DTG-2PCS-PRO-I

Digital direct-to-garment printer
 with 2 Epson I1600 printheads



UN-SP-190-2PCS

Digital sublimation printer machine
 UN-SP-190-2PCS With 2 Epson I3200 printheads
 UN-SP-190-4PCS With 4 Epson I3200 printheads



UN-SP-190-8PCS

Digital sublimation printer machine
 With 8 Epson I3200 printheads

Electric iron with water bottle feed



UN-300L
UN-300L 138*224mm
UN-300 120*209mm

UN-94AL
UN-94AL 138*224mm
UN-94A 120*209mm

UN-2003 / UN-96
115*200mm

Steam Iron



UN-600
147*205mm

UN-300
100*204mm



UN-6PC
147*205mm

UN-3PC
108*191mm

UN-200S
64*192mm

UN-D
170*233mm

Electric Iron



UN-B-200
125*225mm

UN-2128S
112*210mm

Iron Shoes



SP-420
206x103mm

SH-350
206x109mm

LEMM
200x118mm

UN-1
195x67mm

TEFLON HOSE
3m 4m 5m



UN-9000
Steam boiler with electric iron
1.6KW 1.8L

UN-2035
Steam boiler with electric iron
1.6KW 3.5L

UN-B750N
Steam boiler with electric iron
1.6KW 4L



UN-ST-6
Steam boiler with electric iron
1.6KW 4L

UN-2050
Steam boiler with electric iron
2.2KW 5L

UN-ST-8S
Steam boiler with electric iron
3KW 6L



UN-ST-01A-2D
Smart steam generator with steam iron
4KW 7.8L 5.7kg/h

UN-HFS-6
Intelligent voice-controlled energy-saving electric steam generator
5KW 7.8L 6.5kg/h

UN-A009
Automatic electric steam boiler
4KW 11L 5.7kg/h



3 KW
Electric steam boiler
DLD3-0.4-A1 Automatic water feed



6 KW
Electric steam boiler for electric iron
DLD6-0.4-B3 6KW



6/9/12KW - popular
Full auto electric steam boiler
DLD6-0.4-E2 6KW
DLD9-0.4-E2 9KW
DLD12-0.4-E2 12KW



6/9/12KW - economical
Full auto electric steam boiler
DLD6-0.4-B2 6KW
DLD9-0.4-B2 9KW
DLD12-0.4-B2 12KW

6/9/12KW - energy saving
Full auto electric steam boiler
DLD6-0.4-F4 6KW
DLD9-0.4-F4 9KW
DLD12-0.4-F4 12KW



18/24/36/48/60/72KW
Full auto electric steam boiler
DLD18-0.4-A2 (18KW) LDR0.09-0.7-1 (36KW)
DLD24-0.4-A2 (24KW) LDR0.09-0.7-1 (48KW)
LDR0.09-0.7-1 (60KW)
LDR0.09-0.7-1 (72KW)



108/120KW
Full auto electric steam boiler
LDR0.15-0.7-1A 108KW
LDR0.15-0.7-1A 120KW



UN-HFS-6
High frequency electromagnetic steam generator
UN-HF-6 6KW 7.2kg/h
UN-HF-9 9KW 10.8kg/h
UN-HF-15 15KW 18kg/h



UN-VFS-30KW
Intelligent variable frequency steam generator
UN-30KW 40 kg/h
UN-40KW 55 kg/h
UN-50KW 70 kg/h
UN-60KW 84 kg/h
UN-80KW 112 kg/h
UN-100KW 130 kg/h



LSS-0.5-0.7-S (500kg/h)
Biomass steam boiler
LSS-0.12-0.6-S 120kg/h LSS-0.5-0.7-S 500kg/h
LSS-0.15-0.6-S 150kg/h LSS-0.75-0.7-S 750kg/h
LSS-0.2-0.6-S 200kg/h LSS-0.1-0.7-S 1000kg/h
LSS-0.3-0.7-S 300kg/h LSS-0.15-0.7-S 1500kg/h



TP-80150A
Basic vacuum ironing table
TP-65120A 65*120cm
TP-70140A 70*140cm
TP-80150A 80*150cm
TP-110200 110*200cm without arm



TDZ-80120A
Vacuum ironing table with pedal limit switch control and electric heating on surface
TDZ-80120A 80*120cm
TDZ-80150A 80*150cm
Economical model without electric heating
TDE-80120A 80*120cm
TDE-80150A 80*150cm



TDG-80120A
Vacuum ironing table with built-in 4.5 KW steam boiler
TDG-80120A 80*120cm
TDG-80150A 80*150cm

Optional devices
U: vacuum exhaust
UG: vacuum exhaust + gantry + balancer



TDZ-Q3-UL
U-shape vacuum ironing table with electric heating
Surface height 90cm
TDZ-Q3-U
TDZ-Q3

Optional:
U: vacuum exhaust
L: light bar + spring balancer



TDZ-Q1
Surface height 80cm



TDZ-Q2-U
TDZ-Q2
Surface height 87cm



TDZG-Q3-L
with 2.5KW steam boiler



TDZC-Q3-UL
with blowing fan



TDZ-K
Vacuum ironing table specialized for trousers



UN-T1911
Intelligent ironing machine



TDJ-D1
Ironing machine
950*2100mm



UN-460A
Spot eliminating machine



UNLL-G58
Stand-up collar



UNSJ-A68
Both shoulders



UNXL-018
Armhole



UNXS-012
Sleeve cap



UNZP-C120-DS
Left and right body panels rotation type



UNDS-G98-DSL
Left body panel
UNDS-G98-DSR
Right body panel



UNZP-C120-HB
Left & right back yoke rotation type



UNHB-G35-HBL
Left back
UNHB-G35-HBR
Right back



UNBT-G35
Double lapel



UNPX-G35
Sleeve pressing



UNWN-G35
Universal iron pressing



UN-DJT-WB
Steam pressing machine
universal type



UN-DJT-BA
Electric heating pressing machine
for shirt collar & cuff



UN-DJT-BB
Electric heating pressing machine
for shirt sleeve



UN-DJT-BC
Electric heating pressing machine
for shirt side seam



UN-DJT-BD
Electric heating pressing machine
for shirt back seam



UN-DJT-BE
Electric heating pressing machine
for shirt arm



UNKF-018
Trousers side seam



UNKY-012
Trousers waist



UNTC-012
Trousers crotch seam



UNTL-026
Trousers legs



UNPS-550
Pants seam ironing table



UNTF-550
Trousers rear finishing ironing table



RZ-II
Portrait finishing machine



UN-TK-404
Four station automatic pants finisher



TDZ-101
Pants finishing machine



UN-8401P
Automatic shirt armhole press



UN-8401A
Double rotation armhole press



UN-8401AB
Double rotation armhole press



UN-8402P
Automatic sleeve side seam press



UN-8208
Automatic coat front left press



UN-8209
Automatic coat front right press



UN-8211
Automatic outside sleeve press



UN-8212
Automatic inside sleeve press



UN-8402A
Double rotation side seam press



UN-8403
Sleeve placket press-double head



UN-8243M
Automatic collar and cuff press machine



UN-8404P
Automatic shirt yoke press



UN-8216
Automatic side seam press



UN-8218
Automatic utility press



UN-8318
Automatic legger press



UN-8219
Automatic topper press



UN-8404A
Double rotation yoke press



UN-8406P
Traveling head automatic placket fusing machine



UN-8406L
Traveling head automatic placket fusing machine-ARC



UN-8247
Hot and coll head collar creasing fusing machine-HMI interface



UN-9102
Traveling head shirt side seam press



UN-9102AB
Single head shirt side seam press



UN-9156AD
Traveling head shirt yoke press



UN-9156AD
Traveling head shirt yoke press



UN-8248A
Hot and coll head collar creasing press



UN-8248AB
Double hot and coll head collar creasing press-HMI interface



UN-8201
Automatic right shoulder press



UN-8202
Automatic left shoulder press



UN-9862
Double rotation front left/right press



UN-9103
Traveling head shirt yoke press



UN-9104
Vertical men's left chest press



UN-9105
Vertical men's right chest press



UN-9106
Traveling head shirt back press



UN-9143M
Automatic man shirt collar and cuff press



UN-8403
Sleeve placket press-double head



UN-8412
Yoke neck press



UN-9204
Vertical lady left chest press



UN-9205
Vertical lady right chest press



UN-9256AD
Traveling head lady blouse left sleeve press



UN-9256AD
Traveling head lady blouse right sleeve press



UN-9602
Traveling head shirt side seam press



UN-9602A
Traveling head shirt side seam press



UN-9403A
Automatic double yoke press machine



UN-9403AB
Automatic double yoke press machine



UN-9206
Traveling head lady shirt back press



UN-9243M
Automatic lady shirt collar and cuff press



UN-9802
Traveling head shirt side seam press



UN-9803A
Automatic double yoke press machine



UN-9604
Automatic men's left chest press



UN-9605
Automatic men's right chest press



UN-8956AD
Automatic double sleeve press machine



UN-9862
Double rotation front left/right press machine



UN-9803AB
Automatic double yoke press machine



UN-9804
Traveling head lady left chest press



UN-9805
Traveling head lady right chest press



UN-9806
Traveling head shirt back press machine



UN-9643A
Traveling head shirt collar and cuff press



UN-9643AB
Traveling head shirt collar and cuff press



UN-9202
Traveling head lady side seam press



UN-9203
Traveling head lady yoke press



UN-9856AD
Automatic double sleeve press machine



UN-9843A
Traveling head shirt collar and cuff press



UN-9843AB
Traveling head shirt collar and cuff press



UN-3150
Automatic cold and hot three-headed hesive flattening machine



UN-C101
Single head cap ironing machine



UN-C102
Double-head cap ironing machine



UN-CL102
Cap front panel pressing machine



UN-CL104
Cap curved visor blocking machine



UN-CL1031
Multi-function cap ironing machine
UN-CL1031 with cap front panel pressing and ironing
UN-CL1032 with cap curved visor blocking and ironing
UN-CL1033 with cap front panel pressing, curved visor blocking and ironing



UN-CL18
Cap visor cooling machine



UN-81
Automatic collar trimming, turning and blocking machine



UN-QF03
Step motor collar trim/turn machine



UN-FC100
Shirt label angle machine



UN-QF06
Step motor collar trim/turn+block machine



UN-ZK-750
Flap stop machine



UN-85P
Automatic cuff blocking machine



UN-QC01
Knit lining cut machine



UN-FS2700-72
Fabric shrinking and forming machine
(working width 2200mm)
UN-FS2700-72 working width 1800mm
UN-FS2700-88 working width 2200mm

AUTO-SHARPENING STRAIGHT KNIFE CUTTING MACHINE



CZD-3E
Servo type with speed 1000-4500 rpm adjustable



| Model | Blade size - inch | Power |
|---------|--------------------|------------------------|
| CZD-3E | 6 8 10 12 13 15 | 1600W/2000W |
| CZD-3 | 6 8 10 12 13 15 17 | 550/750/850/1000/1200W |
| CZD-103 | 6 8 10 12 | 550/750/850/1000W |
| CZD-108 | 5 | 370W |

Optional:



Round knife cutting machine



RSD-90 **RSD-100/ RSD-110** **RSD-125** **SERVO TYPE** **WIRELESS SERVO TYPE**
RCS-100 RCS-110 RCS-125
RCS-100B RCS-110B RCS-125B



RSD-110A (long handle + rail) **RSD-70** **RSD-65** **RSD-50** **RSD-C50/C1** Built-in battery



UN-900B
Band knife cutting machine

UN-1200B
Band knife cutting machine

| Model | UN-700A/B | UN-900A/B | UN-1200A/B |
|-----------------------------------|---|-------------|-------------|
| Space from knife to the rightmost | 700mm | 900mm | 1200mm |
| Cutting height | 180mm | 180mm | 200mm |
| Table size | 1200*1400mm | 1500*1800mm | 1500*2400mm |
| A model | 3 classes of speed adjustable | | |
| B model | Stepless speed adjustable with frequency inverter | | |
| Optional | S = safety device | | |



UNDB-1
Manual cloth end cutter

UNDB-2
Semi-auto cloth end cutting machine

UNDB-3
Full auto cloth end cutting machine

UNDB-4
Intelligent automatic cloth cutting machine



CZ-230
Cloth driller
CZ-230 or DZ1-2

CZ1-2
Hot cloth driller

CZ-3Z
Electronic hot driller
Optional: Maximum temperature 260°C

CZ-201H
Hot cloth driller

CZD-200H
Heated cutter
Optional: 24", 32"



CZ-188F
Double sided cashmere splitting machine

UN-R1-3
Electric thermal trademark cutter
260W 20cm

UN-R1-1A
Electric thermal trademark cutter
120W 14cm
UN-R1-1A 2 classes of temperature adjustable
UN-R1-1B Stepless temperature adjustable

UN-R1-1C
Electric thermal trademark cutter
120W 17cm
UN-R1-1C Stepless temperature adjustable
UN-R1-1D 2 classes of temperature adjustable
UN-R1-1F Stepless temperature adjustable

UN-R1-2
Electric thermal trademark cutter
50W

Automatic fabric cutting machine

UN-D X 9 - 1817

| | | | |
|------------------------|--|------------------------------------|---|
| D: Strengthen the body | X: high accuracy high speed head (6500r/min) | Cutting height 7: 7cm 9: 9cm | Cutting area 1818: 180x180cm 1820: 180x200cm 1822: 180x220cm |
|------------------------|--|------------------------------------|---|

- Continuous cutting while moving
- Knife Intelligence
- Standard with air cooling
- Max cutting height of 7CM / 9CM after vacuum compression
- Automatic identification of outside and inside corners of cut part contour
- Automatic reduction of cutting speed of parts with low parts distance to improve cutting quality

Applicable fabrics:
High precision knitting, weaving, denim, leather, car seats, car interiors, car interior and other fabrics



Double knife feet and three poles make cutting process more stable and accurate
Double stone rotary grinding, complete the grinding knife once, the knife more evenly, save the grinding time
Second covering device, reduce the frequency of gas filling, high cutting efficiency

UN-D L 8 - 1817

| | | | |
|------------------------|----------------------------------|--------------------------|---|
| D: Strengthen the body | L: high accuracy head(4500r/min) | Cutting height 8: 8cm | Cutting area 1818: 180x180cm 1820: 180x200cm 1822: 180x220cm |
|------------------------|----------------------------------|--------------------------|---|

- Continuous cutting while moving
- Knife Intelligence
- Standard with air cooling
- Max cutting height of 8CM after vacuum compression

Applicable fabrics:
High precision knitting, weaving, bag, PU, down jacket, yoga clothes, non-trace underwear and other elastic fabrics



UN-S L 8 - 3317

| | | | |
|---------------|----------------------------------|--------------------------|--|
| S: Basic body | L: high accuracy head(4500r/min) | Cutting height 8: 8cm | Cutting area 3317: 330x170cm 3320: 330x200cm 3331: 330x310cm 2517: 250x170cm 2520: 250x200cm 2523: 250x230cm |
|---------------|----------------------------------|--------------------------|--|

- Continuous cutting
- Knife Intelligence
- Standard with air cooling
- Max cutting height of 8CM after vacuum compression

Applicable fabrics:
High-precision knitting, weaving, bag, PU, down jacket, etc.



UN-S K - 1817

| | | |
|---------------|---------------------------------|---|
| S: Basic body | Max. Cutting height 7cm/11cm | Cutting area 3317: 330x170cm 3320: 330x200cm 3323: 330x230cm 2517: 250x170cm 2520: 250x200cm 2523: 250x230cm 2017: 200x170cm 2020: 200x200cm 2023: 200x230cm |
|---------------|---------------------------------|---|

- Standard with air cooling, optional water cooling system
- Max cutting height of 7CM / 11CM after vacuum compression
- 4500r/min

Applicable fabrics:
Knitting, weaving, bag, polar fleece



Double knife feet and three poles make cutting process more stable and accurate
Double stone rotary grinding, complete the grinding knife once, the knife more evenly, save the grinding time

UN-A7
Automatic fabric spreading machine

Model:UN-A7
Max fabric width: 1600/1900/2100mm available
Max fabric weight: 60kgs
Max fabric roll diameter: 550mm
Max spreading speed: 100m/min
Standard paving height: 230mm
Standard elevation: 300mm
Custom heightening: 350mm

- Optional devices:
- Multi-sheet spreader
 - Front and rear cloth pressing device
 - Import Anti-static Film-Set
 - De-static device
 - Second and third edging device
 - Automatic sharpening
 - Arbitrarily set the opposite position
 - MES manufacturing management system
 - Mobile Telecontrol



UN-A8-190S
Automatic fabric spreading machine

Adjustable spreading width:
160cm to 190cm, and more width available
Fabric roll diameter: single 20cm / double 15cm
Cutting height: up to 60cm
Fabric tension control: 60kg max.



UN-S170
Manual fabric spreading machine



UW-2
Fabric releasing machine



UN-FR188-72
Automatic fabric rolling machine
UN-FR188-72 for cloth width 1850mm
UN-FR188-88 for cloth width 2250mm



UN-780Y-180
Fabric inspection machine with auto releasing, rolling and edge aligning device for woven and knitting fabric
UN-780Y-180 180cm width
UN-780Y-240 240cm width



UN-MC1600PQ
Inkjet and cutting plotter
UN-MC1600PQ Max print 160cm and cutting 160cm
UN-MC1800PQ Max print 180cm and cutting 160cm
UN-MC2000PQ Max print 200cm and cutting 180cm



UN-MC1900AI
Inkjet plotter
UN-MC1900AI Max print 190cm
UN-MC2100AI Max print 210cm
UN-MC2300AI Max print 230cm



UN-90150FPQ
Flat-bed inkjet and cutting plotter
UN-90150FPQ 90*120cm
UN-120150FPQ 120*150cm



UN-CD90120
Digitizer
UN-CD90120 90*120cm
UN-CD120150 120*150cm

UN-U2200

Ultrasonic tape cutting machine (right angle / bevel)

UN-U2200
with 100mm cutting width
for right angle and 35mm for bevel
UN-U2100
with 150mm cutting width
for right angle only



UN-150LR

Automatic tape cutter with stacking function

UN-150LR cold & hot knife
UN-150HX round shape cutter



UN-130LR

Heavy duty automatic tape cutter

UN-130LR
cold & hot knife;
standard with 20cm cutting width
UN-130LR(30)
cold & hot knife;
with 30cm cutting width
UN-130L
cold knife;
standard with 20cm cutting width
UN-130L(30)
cold knife; with 30cm cutting width
UN-130R
round shape cutter;
with 2-10 cm cutting width



UN-120LR

Automatic tape cutter

UN-120LR cold & hot knife
UN-120L cold knife
UN-120H hot knife
UN-120SH hot knife with sensor
UN-120HL cold knife with sensor
UN-120HLR cold & hot knife with sensor
UN-120R round shape cutter
UN-120HX bevel cutter



UN-680S-2A

Automatic fabric rolling machine with auto edge aligning

Max operation length 2.1m
Max fabric roll dia: 400mm



UN-C2000D

Automatic fabric rolling machine with auto edge aligning

Max operation length: 2000mm
Max fabric roll dia: 400mm



UN-SC2013AS

Full automatic computerized strip cutter

Max operation length: 2100mm
Band width: 3mm-1680mm
Max roll dia: 280mm
Blade dia: 400mm



UN-SC2700DB

Full automatic computerized strip cutter

Max operation length: 2000mm
Band width: 4mm-1700mm
Max roll dia: 280mm
Blade dia: 250mm-400mm



UN-FH9000D

High speed folding and joining machine

Max fabric width: 1700mm
Max folding width: 850mm



UN-X8BZ

Intelligent automatic circular fabric tape cutting machine with auto edge-alignment

Standard with 3 blades
Cutting tape width: 2-12 cm
Fabric width: 30-200 cm

UN-X8BT regular model
without auto edge-alignment
function



UN-C300

Automatic tape cutter - wide type

UN-C160 160mm UN-C600 600mm
UN-C200 200mm UN-C700 700mm
UN-C250 250mm UN-C800 800mm
UN-C300 300mm UN-C900 900mm
UN-C400 400mm UN-C1000 1000mm
UN-C500 500mm



UN-C120L-W

Automatic tape cutter with stacking function

UN-W120L cold knife
UN-W120LR cold & hot knife



UN-C100-C

Automatic elastic tape cutter

UN-100-C cold & hot knife



UN-S150LR

Automatic tape cutter

UN-S150L cold knife
UN-S150R hot knife
UN-S150LR cold & hot knife
UN-S150HLR cold & hot knife with sensor



UN-S110LR

Automatic tape cutter - economical type

UN-S110R hot knife
UN-S110LR cold & hot knife
UN-S110HLR cold & hot knife with sensor



UN-815

Cloth tape cutting machine

| Model | Tape length | Tape width | Knife |
|--------|-------------|------------|--------------------|
| UN-815 | 15-1900mm | 50mm | cool knife |
| UN-817 | 15-1900mm | 60mm | cool and hot knife |
| UN-818 | 15-1900mm | 50mm | round velcro tape |



UN801D/UN802D

Direct drive cloth tape cutting machine

UN801D single-blade
UN802D double-blade



UN801A/UN802A

Cloth tape cutting machine

UN-801A single-blade
UN-802A double-blade



UN-933A

Automatic cloth tape cutting and rolling machine

UN-933A speed adjustable, ideal for elastic fabric
UN-911A for regular fabrics



UN-VK1625
Vibrating cutting machine



UN-VK1625 1600*2500mm
UN-VK2025 2000*2500mm



UNC-1810ZQS
Panoramic camera positioning laser cutting machine



UNC-1920ZQRS
High speed laser cutting machine



UNC-1610Z/1810Z
Laser cutting engraving machine

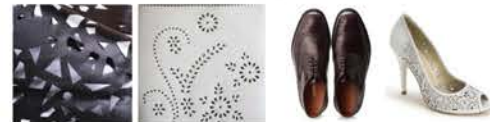

UNLC-1410C/1610C/1810C
Laser cutting engraving machine



UN-A3-G2-R6-6080-CM
CNC leather punching machine



A1-S
CNC leather punching machine



UN-XP1509
High speed template cutting and milling machine



UN-P1509
Classic template cutting milling machine



UN-FT1509
Flatbed template cutter



UN1209F
Visual line drawing system(inkjet model)



UN1606
Vibrating head cutting machine (double head)



UN-S6090
Intelligent plate cutting machine



Speed adjustable

SK-1923

Leather skiving machine with trash suction device



Speed adjustable

SK-1925

Leather skiving machine



SK801
SK801A with sealed cover

SK801

Leather skiving machine



UN320-520

Computerized leather splitting machine



UN-XCLB-120 120KN=12T
UN-XCLB-140 140KN=14T
UN-XCLB-200 200KN=20T
UN-XCLB-250 250KN=25T

UN-XCLB-200

Hydraulic clicking press machine with turning arm



UN-XCLB-100C 100KN=10T
UN-XCLB-120C 120KN=12T
UN-XCLB-160C 160KN=16T
UN-XCLB-200C 200KN=20T
UN-XCLB-250C 250KN=25T
UN-XCLB-300C 300KN=30T

UN-XCLB-300C

Precise four column hydraulic clicking press machine



UN-250KN

Hydraulic movable head die cutting machine



UN-TK-20

Leather strap cutting machine



UN-1934 UN-1933B

UN-1934

Thread blowing machine
UN-1934 with digital display
UN-1933B with sensor, power saving



UN-TX2-1M

Thread trimming machine (1 motor)



UN-TX2-2M

Thread trimming machine (2 motor)



UN-TX-100V

Thread trimming machine with brushless motor



UN-TX-98T 2 motor

UN-TX-98 1 motor

UN-TX-98T

Thread trimming machine with brushless motor



UN-TX-2022

Thread trimming machine with brushless motor



UN-MT191-BL

Thread trimmer
It mounts on sewing machine head like interlock UN1500 series.



UN-TX-2022T

Thread trimming machine with sensor with brushless motor



UN-T180-F

Thread trimming machine for trousers with trousers turning



UN-560A

Thread suction machine
3KW 380V

PACKING MACHINE



UN-P108D
Garment packing machine



UN-P206A
Garment packing machine



UN-P207B
Semi automatic garment packing machine
UN-P217XE
bottom edge can also be sealed



UN-P208E
Automatic garment packing machine with auto sealing bag length adjustment
UN-P218XE
bottom edge can also be sealed



UN-P307B
Shirts flat bagging machine
also good for saree packing



UN-P308C
3 sided seal bagging machine
UN-P308C for light like shirt,towel
UN-P309B for heavy like winter clothes, pillow



UN-K88
Intelligent strapping machine



UN-FPS-1
Automatic T-shirt folding Machine



UN-FPS-S
Automatic shirt folding machine



UN-FPS-FA
Automatic clothes folding & packing machine
capable for T-shirt,Shirt, light coat and trousers.

NEEDLE DETECTOR



UN-630A-100
Needle detector
UN-630A-100 (100mm height FeΦ0.8mm)
UN-630A-120 (120mm height FeΦ1.0mm)
UN-630A-150 (150mm height FeΦ1.2mm)
UN-630A-200 (200mm height FeΦ1.5mm)



UN-168BC-100
Needle detector
UN-168BC-100 (100mm height FeΦ0.8mm)
UN-168BC-120 (120mm height FeΦ1.0mm)
UN-168BC-150 (150mm height FeΦ1.2mm)
UN-168BC-200 (200mm height FeΦ1.5mm)



UN-AD-100
Needle detector-double head
UN-AD-100(100mm height FeΦ0.8mm)
UN-AD-200(200mm height FeΦ2.0mm)
UN-AD-300(300mm height FeΦ3.0mm)
UN-AD-400(400mm height FeΦ4.0-4.5mm)



UN7300-B600-170
Needle detector for production line
UN7300-B400 400mm width 100mm height FeΦ0.8mm
400mm width 130mm height FeΦ1.0mm
UN7300-B600 600mm width 170mm height FeΦ1.2mm
600mm width 200mm height FeΦ1.5mm



UN-L2000-100
Needle detector - large width
Width 2000-4000mm customizable
Height 100mm FeΦ0.8mm / 150mm FeΦ1.0mm
200mm FeΦ1.2mm / 250mm FeΦ1.5mm



UN-WH01
Inspection System



UN-ND6020
Needle detector for production line
600mm width x 200mm height
FeΦ1.5mm



UN-CIL800
Garment inspection lamp



HD-450C
Needle detector - desktop type



HD-20C
Needle detector - handheld type



HD-35C
Needle detector - handheld type



UN-K24T
Smart needle management cabinet
Rotary needle release for easier needle output and replacement



UN-K24B
Smart needle management cabinet



UN-DF-2606X
High-precision intelligent down & cotton filling machine



UN-DF-4606X
Intelligent down & cotton filling machine



UN-C103F
Automatic cuff folding work station



UN1893A
Zipper pre-expansion machine



UN-TM826
Automatic tassels making machine



UN8208R
High-precision intelligent down & cotton filling machine
UN8208R 2 filling port & 8 scales
UN8416R 4 filling port & 16 scales



UN724B
Intelligent down & cotton filling machine
UN714B 1 filling port & 4 scales
UN724B 2 filling port & 4 scales
UN728B 2 filling port & 8 scales



UN-CS380K
Automatic trousers drawstring inserting machine



UN-CS880KM
Automatic trousers and cap drawstring inserting machine



UN-U5
Seam opening machine



UN-BL-402D
Integrated intelligent cotton filling machine



UN612E
Integrated intelligent cotton filling machine
1 filling port & 2 scales



UN-US300
Ultrasonic sealing device



UN-DC2315GP
Fully automatic down/cotton clapping machine



UN-CT168
Cotton tapping machine



UN1101GA
Semi-automatic cotton filling machine
1 filling port & 1 scale



UN-SDS250
Shoelace & drawstring end sealing machine



UN-FK002
Vertical vacuum pants turning machine



UN-FK001
Horizontal vacuum pants turning machine



UN-B966
Electronic button neck wrapping and knotting machine
With regular sewing thread



UN-B10R
Automatic button shank wrapping machine
With hot melting thread



UN-B22
Automatic button wrapping & knotting machine



UN-B10-H
Automatic button shank wrapping machine



UN-B1-1
Economical button wrapping machine
Rated voltage: 220V
Power: 6W
Rated frequency: 50Hz
Weight: 10kg



UN-B1-2
Economical button wrapping machine for hot-melt & sewing thread
Rated voltage: 220V
Power: 65W
Rated frequency: 50Hz
Weight: 12kg



UN-CSCK
String thrusting machine for cord lock



UN-SKJ-01
Rope across machine



UN-20SE
Electronic thread distributor (2 cones)
UN-20SE For sewing thread
UN-20NSE For embroidery thread



UN-20S
Thread distributor (2 cones)
UN-20S For sewing thread
UN-20NS For embroidery thread



UN-20C
Embroidery thread distributor (2 cones)

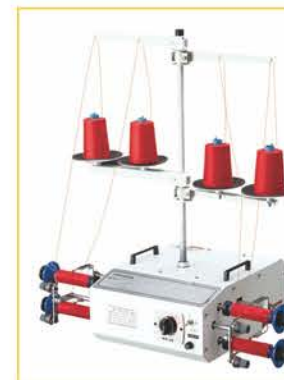

UN-40C
Embroidery thread distributor (4 cones)



UN-10S
Thread distributor (1 cone)



UN-520A
Bobbin thread winder



UN-BW5
Bobbin thread winder



RXQ-10
Mini bobbin thread winder



UN-X550W
Power saving motor
UN-X750W



UN-NS550W
Power saving motor
UN-NS750W



UN-HL737
Power saving motor
400W



UN-MT
Direct drive motor with auto trimmer presser foot lifting and needle stop
size: 12.6mm / 12.7mm / 14.72mm / 15mm / 17mm



Direct drive motor for lockstitch
550W 6000RPM



UN-WR587G
Computerized motor for lockstitch with auto trimmer



UNED-8500R
Direct drive motor for lockstitch



UNMO-550W
Direct drive motor for overlock



UNMI-550W
Direct drive motor for interlock



Direct drive motor for zigzag 2280



Direct drive motor for multi-needle chainstitch



DOL 13H
Clutch motor
DOL13H 250W 2850rpm
DOL12H 400W 2850rpm
DOL12HS 400W 3450rpm
DOL34H 550W 2850rpm
DOL34HS 550W 3450rpm
DOL13L 250W 1425rpm
DOL12L 400W 1425rpm
DOL12LS 400W 1725rpm
DOL34L 550W 1425rpm
DOL34LS 550W 1725rpm



YL4834
Induction motor 400W 1420rpm



Mini motor for household lockstitch
100W/150W
25mm / 29mm thickness



Mini motor for household overlock
150W
29mm thickness





Combined cutting machine table
Width: 1.6m 1.8m 2m 2.2m 2.4m
Length: 1.2m per unit * N units

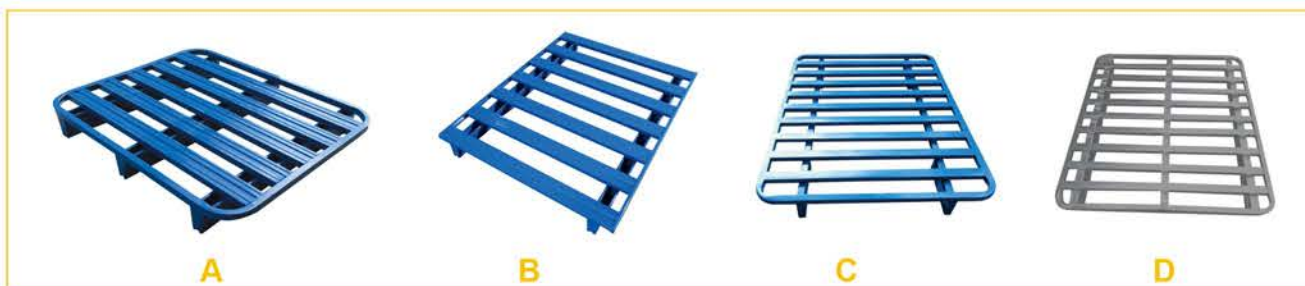

Pallet Series



Heavy-duty rickstand



Single-sided fabric loosening rack Size:190X73X170cm
Fabric loosening rack Size:190X65X130cm



Double sided fabric loosening rack Size:190X138X170cm
Double sided fabric loosening rack Size:190X138X170cm



Three layers cutting piece car Size:120X80X160cm
120X60X160cm
Two layer cutting car Size:120X80X160cm
120X60X160cm



Fence truck Size:120X80X160cm
AGV turnover vehicle Size:120X80X150cm



Fence truck Size:120X80X100cm
Box trolley(semi-open) Size:120X80X90cm



Line rack Size:120X40X185cm
4-door locker Size:90X50X180cm
File cabinets Size:90X40X180cm
File cabinets Size:90X40X180cm



UN-F049 Work bench Size: 39X39X46/59cm
UN-F050 Work bench Size: 39X39X46/59cm
UN-F051 Work bench Size: 39X39X46/59cm
UN-F052 Metallic plate flume Size: 40X76cm/60X76cm (Length customization)



UN-F053 Lathe worker's bench Size: 40X30X48cm
UN-F054 Work bench Size: 40X28X65cm
UN-F055 Backrest chair Size: 40x43x46cm
UN-F056 Packing table Size: 240X120X80cm



UN-F057 Work stool Size: 120X28X49cm
120X28X45cm
UN-F058 Work stool Size: 120X28X49cm
120X28X49cm
UN-F059 Work stool Size: 100X28X45cm
100X28X49cm
UN-F060 Packing table Size: 240X120X80cm

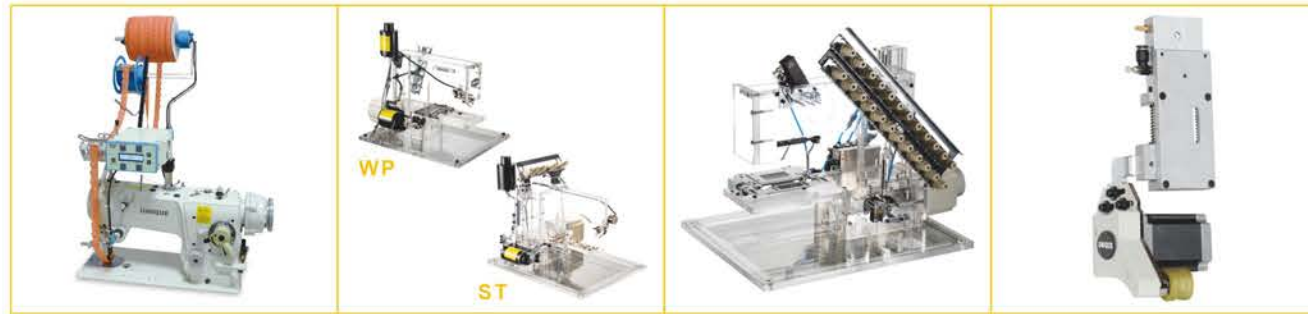

Elastic tape feeder

Auto trimmer device for interlock

Auto trimmer device for multi needle machine

Electronic puller



PL
Puller for 1 & 2 needle lockstitch sewing machine

PS
Puller for 1 & 2 needle lockstitch sewing machine (Small roller)

PT/PT-H
Puller for 1 & 2 needle lockstitch sewing machine (Up and down puller)

PK
Puller for overlock sewing machine (Up and down puller)



PK-SP
Puller for overlock sewing machine (Front type)

PK-2S
Puller for overlock sewing machine (Up and down feed and long cylinder type)

PL-S1
Puller for flat bed interlock sewing machine

PL-S2
Puller for cylinder bed interlock sewing machine



PY-SP
Front puller lockstitch, double needle, interlock, zigzag

PY
For lockstitch, double needle, interlock, etc.

PF/PF-H
Puller for feed off the arm sewing machine

MDL31
Metering device for zigzag sewing machine



Fixed position light
LS-L+ + type
LS-L- -type
LS-L+ + type
LS-L- -type

LED light with back stitch button

UN-LU6
LED light

UN-LUA6
LED light (Adjustable)



LED light
UN-LS16 Basic type
UN-LSA16 Brightness adjustable

LED light
With 10 LED light beads
(With Different quantity LED light beads)

LED light

LED light



UN-S6
Hydrostatic pressure tester

CM-11
Cleaning gun

Tag gun

Electronic suction device



Clipper
Scissors

Cloth storage basket

Steel glove
5 finger
3 finger

Fading fabric marker

PARTS



Hook

Hook

Bobbin case

Bobbin



Needle

Needle plate

Feed dog

Presser foot



Needle clamp

Looper

Pulley

Bobbin winder



Binder

Puller

Thread stand

Seam guide

TOOLS

TOPDIS



Tape rack

Tape rack

Hanger with roller

Belt for Fusing machine



Straight cutting machine knife

Straight cutting machine knife

Abrasive belt
Round cutting machine knife
Knife for sewing machine



Seam ripper

Seam ripper

Cloth driller

Plain tracer

Ruller



Screw driver and tools

